

THE HAWAII GEOTHERMAL PROJECT

HGP-A RESERVOIR ENGINEERING

September 1978



MAR 5 1979

HAWAII GEOTHERMAL PROJECT

HGP-A RESERVOIR ENGINEERING

September 1978

by

Paul C. Yuen

Bill H. Chen

Deane H. Kihara

Arthur S. Seki

Patrick K. Takahashi

SUPPORT FOR PROJECT PROVIDED BY:

Department of Energy, Contract EY-76-C-03-1093

Energy Research and Development Administration, Contract E(04-3)-1093

National Science Foundation, Grant GI 38319

State of Hawaii, Grants RCUH 5774, 5784, 5942

County of Hawaii, Grant RCUH 5773

Hawaiian Electric Company, Grants 5809, 5828

University of Hawaii
Holmes Hall 206 2540 Dole Street
Honolulu, Hawaii 96822

ABSTRACT

The Hawaii Geothermal Project well HGP-A has undergone a two-year testing program which included cold water pumpdown tests, flashing flows with measurements of temperature and pressure profiles, and noise surveys. These tests and the data obtained are discussed in detail.

While the pumpdown tests conducted right after the slotted liner had been installed and the mud removed indicated that the well had very poor permeability, HGP-A was flashed successfully on July 2, 1976. Maximum quiescent bottomhole temperature following that initial flash was measured to be 358°C. Comparison of subsequent discharges shows that with each succeeding test, the flow rate has increased, possibly due to the displacement of drilling mud embedded in the wellbore surface. The flow rates range from a maximum of 101 Klb/hr at wellhead pressure of 51 psig to a throttled 76 Klb/hr at 375 psig wellhead pressure, with possible electrical power production of 3.0 to 3.5 MWe.

Temperature and pressure profiles taken during flow tests indicate that the fluid in the wellbore is a mixture of liquid and vapor at saturation conditions. The absence of a liquid level during flashing discharge confirms that flashing is occurring in the formation.

Pressure drawdown and buildup analyses yield a value of transmissibility (kh) of approximately 1000 millidarcy-feet with a pressure drop across the apparently damaged skin of 500-600 psi.

The pressure profiles taken during flashing flow consist roughly of three approximately constant gradient lines that intersect at the junction of the casing and the slotted liner, and at approximately 4300 feet depth, which leads to the conclusion that the major production zones are near bottomhole and in the vicinity of 4300 feet. Furthermore, the data points on the log-log Horner type plot seem to fall on two different but consecutive straight-line approximations. This could be interpreted to be the result of two different production layers with different kh values.

TABLE OF CONTENTS

	Page
ABSTRACT	<i>i</i>
LIST OF FIGURES	<i>iii</i>
LIST OF TABLES	<i>vi</i>
PRELIMINARY TESTS	1
SUMMARY OF PRODUCTION FLOW TESTS	17
November Flow Test (11/3/76 - 11/17/76)	17
December Flow Test (12/12/76 - 12/19/76)	27
January/February Flow Test (1/26/77 - 2/11/76)	28
March-May (3/28/77 - 5/9/77)	33
PRESSURE DRAWDOWN AND BUILDUP ANALYSES	46
1. Pressure Drawdown Analysis	46
2. December Pressure Buildup Analysis	52
3. January-February Pressure Buildup Analyses	56
4. Recalculation of December Data	59
5. Discussion	60
RESERVOIR RECOVERY ANALYSIS	62
NOISE LEVEL REDUCTION	77
SCALE DEPOSITION	80
SUMMARY	84
CHRONOLOGY OF EVENTS AT HGP-A	87
PAPERS AND PUBLICATIONS	94

LIST OF FIGURES

	Page
FIGURE 1 Chronology of Well Testing Events	2
2 Schematic Diagram of Kuster Pressure Recorder	3
3 Schematic Diagram of Wireline System	4
4 Temperature-Depth Plot for HGP-A with Drilling Mud in Borehole	5
5 Temperature-Depth Plot for HGP-A	9
6 Schematic Diagram of HGP-A Wellhead Instrumentation for Flow Test, July 22, 1976	10
7 HGP-A Flow Test, July 22, 1976. Variation in Wellhead & Lip Pressure with Time	12
8 HGP-A Flow Test, July 22, 1976. Variation in Wellhead & Lip Temperature with Time	13
9 Temperature vs Pressure for HGP-A, July 22, 1976, after Four-Hour Discharge	14
10 Temperature vs Depth for HGP-A following Four-Hour Discharge	15
11 Pressure vs Depth for HGP-A following Four-Hour Discharge	16
12 Hawaii Geothermal Project Flow Test Equipment and Instrumentation	18
13 Wellhead Pressure vs Time, November Flow Test	19
14 Wellhead Temperature vs Time, November Flow Test	20
15 Lip Pressure vs Time, November Flow Test	21
16 Total Mass Flow Rate vs Time, November Flow Test	22
17 Steam Flow Rate vs Time, November Flow Test	23
18 Enthalpy of Discharge vs Time, November Flow Test	24
19 Steam Quality vs Time, November Flow Test	25
20 Thermal Power vs Time, November Flow Test	26
21 Temperature Profiles during Flashing, January/February Flow Test	30
22 Pressure Profiles during Flashing, January/February Flow Test	31

LIST OF FIGURES (Continued)		Page
FIGURE 23	Temperature Recovery after January/February Flow Test	32
24	Wellhead Pressure during March-May Flow Test	34
25	Wellhead Temperature during March-May Flow Test	35
26	Lip Pressure during March-May Flow Test	36
27	Total Mass Flow Rate during March-May Flow Test	37
28	Steam Flow Rate during March-May Flow Test	38
29	Enthalpy of Discharge during March-May Flow Test	39
30	Steam Quality during March-May Flow Test	40
31	Thermal Power Output during March-May Flow Test	41
32	Temperature Profiles during March-May Flow Test	43
33	Pressure Profiles during March-May Flow Test	44
34	Log-Log Plot of November Discharge Test Data	47
35	Semi-Log Plot of November Discharge Test Data	48
36	Linear Plot of Initial Data for November Discharge Test	49
37	Log-Log Plot of December Pressure Buildup Test Data	54
38	Semi-Log Plot of December Pressure Buildup Test Data	55
39	Semi-Log Plot of January Pressure Buildup Test Data	57
40	Semi-Log Plot of December Pressure Buildup Test Data	58
41	Water Level Recovery Rates	63
42	Water Level Recovery Rates (With Common Point of Zero Depth)	64
43	Temperature Recovery following July Flow Test	66 & 67
44	Temperature Recovery following November Flow Test	68
45	Temperature Recovery following December Flow Test	69
46	Temperature Recovery following January/February Flow Test	70 & 71

LIST OF FIGURES (Continued)

Page

FIGURE 47	Temperature Recovery following March-May Flow Test	73
48	Pressure Recovery following March-May Flow Test	74
49	Temperature Recovery following March-May Flow Test	75
50	Pressure Recovery following March-May Flow Test	76
51	Noise Levels during July 22, 1976 Flow Test	78
52	Hawaii Geothermal Project. Flow Test Equipment and Instrumentation with Muffler	81
53	Map Showing Sites for Noise Level Readings	82

LIST OF TABLES

		Page
TABLE 1	Mud Loss from Initial Completion of Hole	6
2	Summary of Pumpdown Test	7
3	Throttled Flow Data 1/26/77 - 2/10/77	29
4	Projections Obtained by Extending Data Plots of March-May Flow Test	42
5	Comparison of Discharge Tests at 25 Hours after Initiation of Flow	45
6	Comparison of Pressure Drawdown and Buildup Tests	61
7	Summary of Water Level Recovery	65
8	Permissible Exposures - Noise Level	77
9	Recorded Noise Level, July 19, 1976	79
10	Noise Level Readings on DBA Scale	83
11	Summary of Preliminary Test Results and Analyses	86

PRELIMINARY TESTS

On-site testing of the well began upon initial completion of HGP-A with logging by Gearhart-Owen electronic equipment to obtain standard E, resistivity, gamma ray, two arm caliper, temperature, and cement bond logs. However, the downhole temperatures were found to exceed the temperature tolerance of the cable insulation which is 150°C. Subsequently, Kuster mechanical subsurface temperature and pressure recorders were used to measure downhole conditions. A chronology of events is given in the Appendix and summarized graphically in Figure 1. Figure 2 is a schematic diagram of the Kuster pressure recording assembly, which is 66 inches long and 1-1/4 inch in diameter. Its upper temperature limit is 370°C. Figure 3 is a schematic diagram of the wireline system used to position the instrument packages in the wellbore. The temperature and/or pressure recorder is hooked onto a 0.082" stainless steel wire and placed in the lubricator, a device which allows operation of the measurement equipment during flashing. The lubricator is constructed of aluminum and is rated at a pressure of 4,000 psi. The wireline is raised and lowered using a winch run by a gasoline engine. A depth indicator is part of the entire system.

The temperature profiles measured after the termination of mud circulation upon completion of drilling is shown in Figure 4. All of these profiles were taken with mud in the borehole. The maximum depth of the initial profile taken on April 28 was limited by the length of the 3/4" cable which was used to lower the instrument assembly. It was feared that the 0.082" stainless steel wire would not be strong enough to pull the assembly up in the event that a cave-in or obstruction of some sort occurred, as the slotted liner had

	1976										1977						
	A	M	J	J	A	S	O	N	D	J	F	M	A	M	J	J	A
WELL STATUS																	
Airlifting			••••						•								
Preliminary Flow and Tests			•	•••••			•••	•	•			••					
Throttled Flow Test									••		••••						
Production Flow Tests				•				••••	••			••••••••					
ACTIVITY																	
Pressure Drawdown Measurements								••••									
Pressure Buildup Measurements									••••	••	••••••	••		•			
Temperature Profile Measurements	••••••••	••••••••	••••••••	••••••••	••••••••	••••••••	••••••••	••••••••	••••••••	••••••••	••••••••	••••••••	••••••••	••••••••	••••••••	••••••••	••••••••
Pressure Profile Measurements			••••••••	••••••••	••••••••	••••••••	••••••••	••••••••	••••••••	••••••••	••••••••	••••••••	••••••••	••••••••	••••••••	••••••••	••••••••
Water Level Measurements								••••••••	••••••••	••••••••	••••••••	••••••••	••••••••		••••••••	••••••••	••••••••
Downhole Water Sampling					•••		••	•	•		••	•	•	•			

Figure 1. Chronology of Well Testing Events

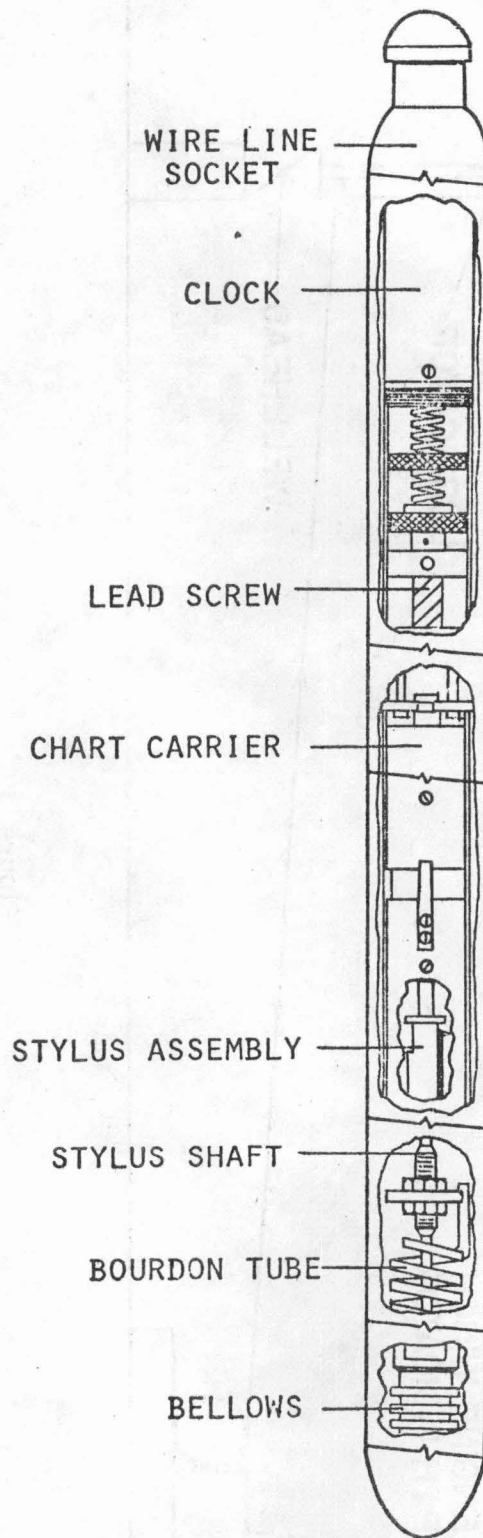

Figure 2. Schematic Diagram of Kuster Pressure Recorder

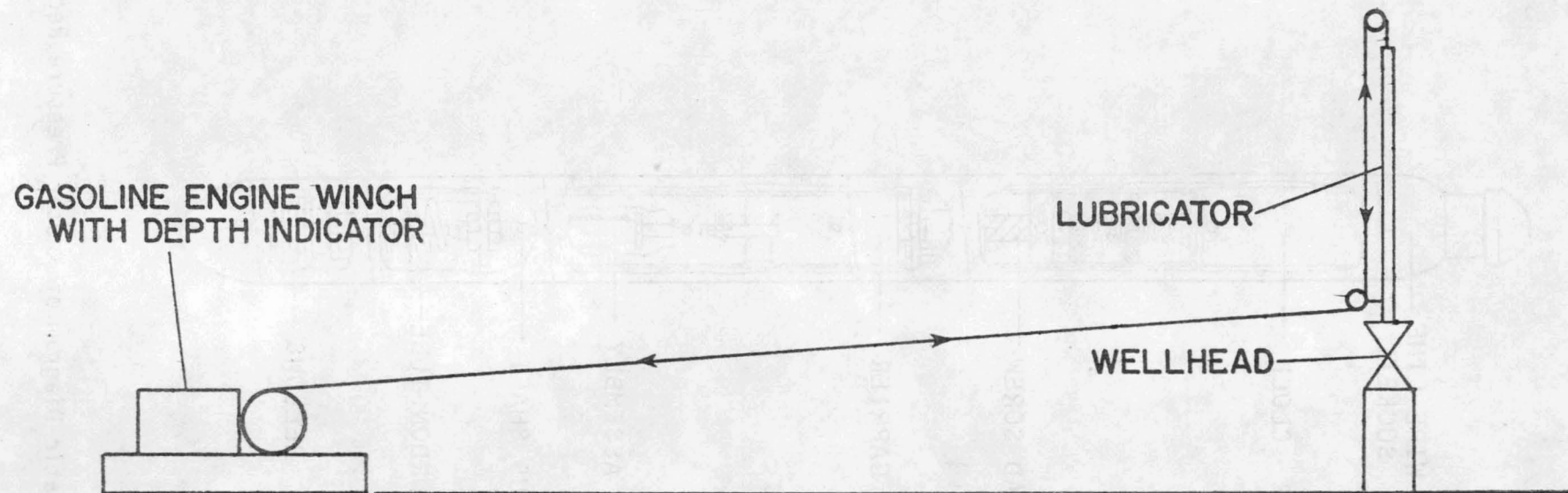

Figure 3
SCHEMATIC DIAGRAM OF WIRELINE SYSTEM

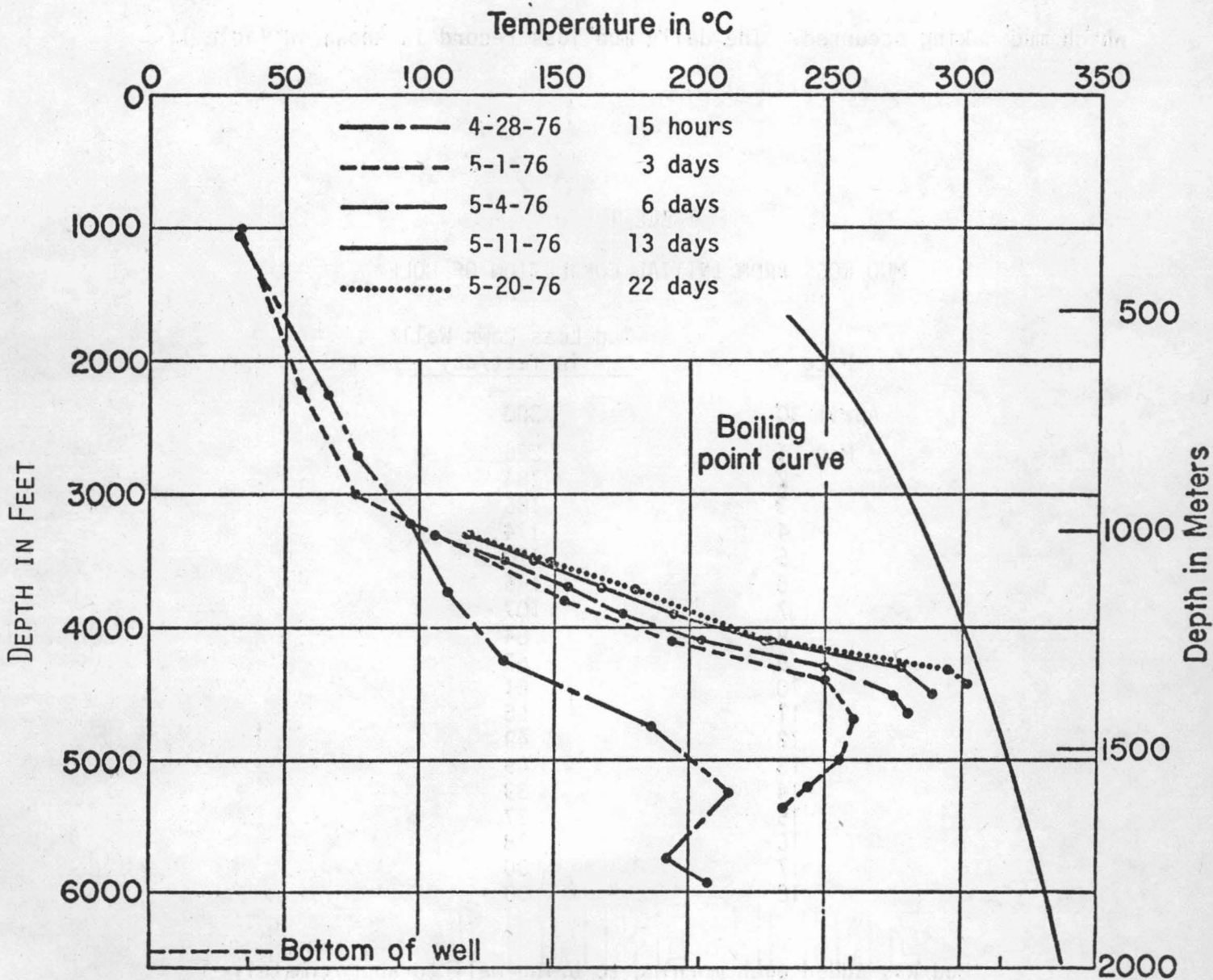

Figure 4. Temperature-Depth Plot for HGP-A with Drilling Mud in Borehole

not been installed yet. For the profiles taken after April 28, the maximum depths at which temperatures were measured give an indication of the rate at which mud caking occurred. The daily mud loss record is shown in Table 1:

TABLE 1
MUD LOSS FROM INITIAL COMPLETION OF HOLE

<u>Date</u>	<u>Mud Loss Down Well* in feet/day</u>
April 30	300
May 1	286
2	184
3	186
4	174
5	170
6	146
7	107
8	84
9	67
10	61
11	55
12	49
13	49
14	39
15	37
16	38
17	30
18	30

*Mud was added each morning to bring well to approximately the same level.

Following installation of the slotted liner, washing the mud out of the borehole was completed at 8:30 PM on June 5. A pumpdown test in which surface water was pumped into the borehole was conducted on June 6 and 7. A summary of this test is given in Table 2:

TABLE 2
SUMMARY OF PUMPDOWN TEST

<u>Date</u>	<u>GPM</u>	<u>Time of Flow (minutes)</u>	<u>Volume (gal)</u>	<u>Back Pressure (psig)</u>
June 6	340	46	15,640	700 ⁺
June 6	108	105	11,340	500 ⁺
June 6	108	60	6,480	500 ⁺
June 6	200	55	11,000	600 ⁺
June 6	300	70	21,000	700 ⁺
June 6	530	10	5,300	750 ⁺
June 6	630	7	4,410	800 ⁺
June 6	300	8	2,400	700 ⁺
June 6	200	5	1,000	600 ⁺
June 6	100	6	600	500 ⁺
June 7	300	3	900	---
June 7	100	180	18,000	300
			<u>TOTAL:</u>	<u>98,070</u> gal

For comparison purposes, the rise in back pressure as the flow rate is increased to 300 gpm can be used as a rough indicator of permeability as follows:

20 psi or less = high permeability

up to 75 psi = moderate permeability

more than 150 psi = very poor permeability (non-producing well).

However, external factors such as the caking of drilling mud could produce erroneous results.

Temperature profiles measured before, during, and after the pump down tests are shown in Figure 5. The curve labelled 1 was taken 12-1/2 hours after washing out the mud but before the pump down tests were started. Curves 2 and 3 were taken 17 hours and 36 hours after washing, between runs of the pump down tests. Following completion of the pump down tests, three temperature profiles were taken. These, labelled curves 4, 5, and 6, were measured 27-1/2 hours, 4 days, and 8 days, respectively, after completion of the pump down tests. Temperature recovery and further heating of the wellbore fluid is seen to be quite rapid.

Air lifting was used to artificially induce the well to flash. In air lifting, air is injected into the water column, thereby displacing some of the liquid, and causing the liquid level in the wellbore to rise, eventually reaching the surface. As liquid flows out of the wellbore, hotter liquid from deeper in the well rises, and if the conditions are right, the temperature of the fluid exceeds the boiling point temperature at that pressure, causing the liquid to flash into vapor.

On June 22-24, airlifting was attempted, using two 100 psi, 175 cfm air compressors. However, this attempt failed when a 250 foot length of air hose was lost in the well. A second attempt on July 2 was successful and HGP-A was flashed for approximately four minutes.

On July 19, the well was flashed for 50 minutes, on July 21 for 30 seconds to check instrumentation, and then for a longer period of four hours on July 22 to obtain preliminary values for wellhead pressure and temperature, and total mass flow rate.

The four hour well flashing on July 22 was accomplished using the wellhead instrumentation shown in Figure 6. The sonic flow, lip pressure method of

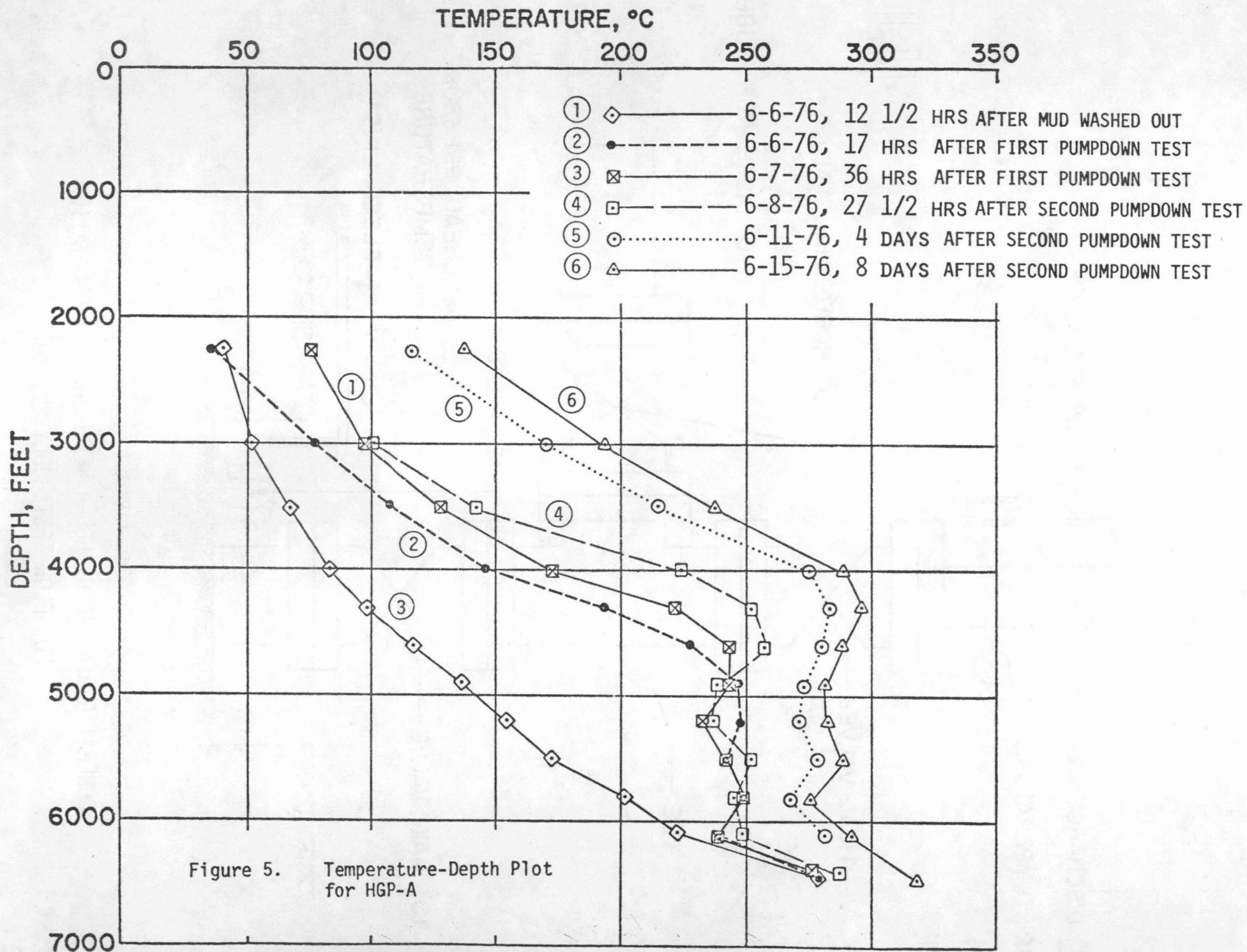

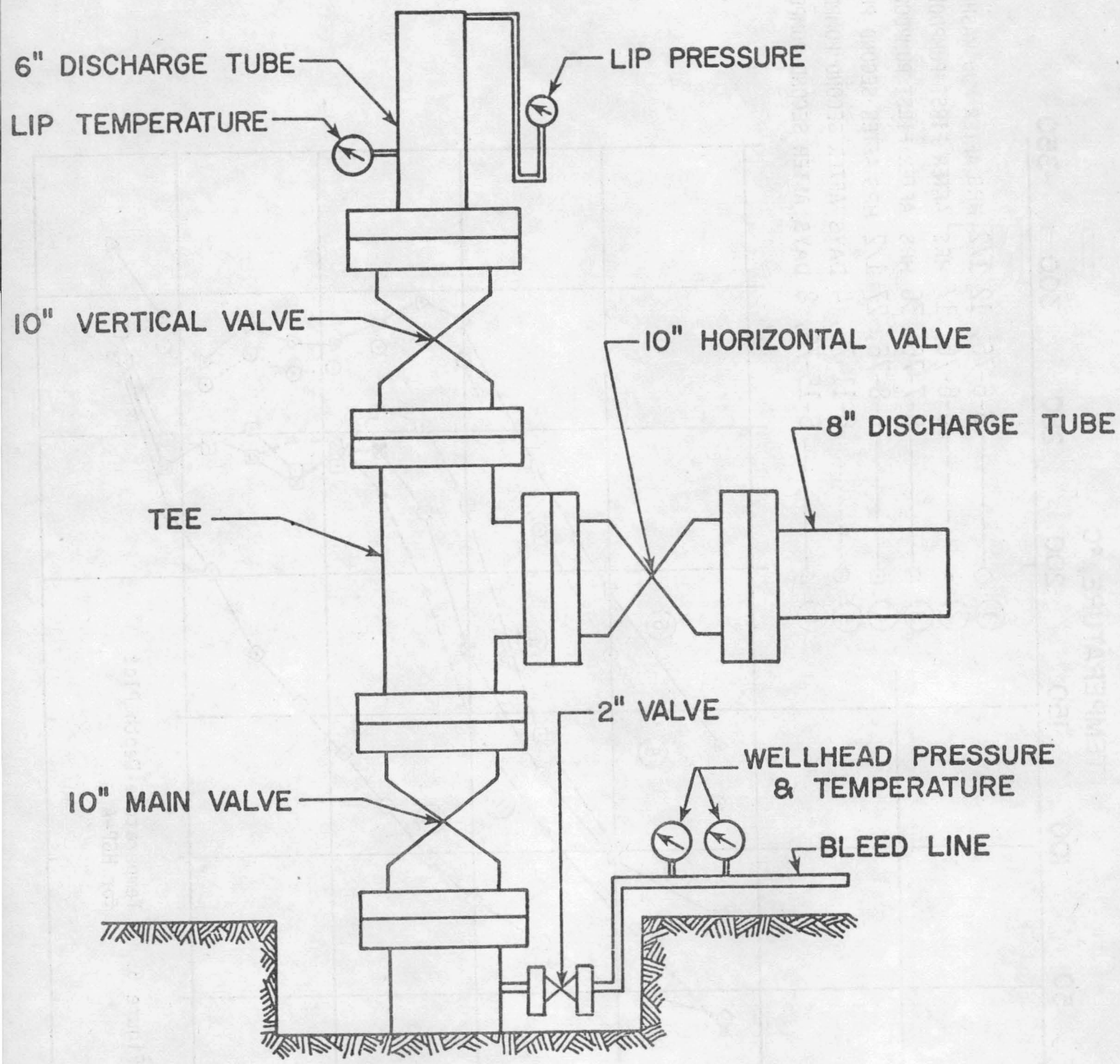

Figure 6

SCHMATIC DIAGRAM OF HGP-A WELLHEAD INSTRUMENTATION
FOR FLOW TEST, JULY 22, 1976

James¹ was used to obtain total mass flow rate with lip pressure being measured at the end of a vertical 6" discharge tube. In addition, an 8" discharge tube mounted horizontally was also flowed for a brief time. Wellhead pressure and temperature were obtained from a bleedline controlled by a 2" valve.

Results of the four-hour flashing are shown in Figures 7 and 8 which give wellhead and lip pressure, and wellhead and lip temperature, respectively. The lip pressure at the end of four hours was 23 psig, which corresponds to a mass flow rate of about 166,000 lbs per hour, assuming a specific enthalpy of 800 BTU/lbm.

Figure 9 shows a plot of temperature versus pressure for HGP-A a few hours after the four-hour flashing on July 22. The number adjacent to each data point represents the depth at which that data point was taken. Also on the figure is the boiling point for pure water. At the time that the data were taken the wellbore contained a saturated mixture of liquid and vapor from a depth of 1000 feet to 4600 feet.

Figures 10 and 11 are plots of temperature and pressure versus depth for HGP-A for the indicated times after the flashing on July 22, 1976. As shown in Figure 10, the temperature profile obtained one week after the flashing was fairly close to equilibrium, except that the portion of the well that is cased is continuing to decrease slowly in temperature. The temperature profiles also appear to indicate the the major production regions are probably between 3,500 and 4,500 feet and around 6,000 feet.

¹ James, Russell, "Measurement of Steam-Water Mixtures Discharging at the Speed of Sound to the Atmosphere", New Zealand Engineering, pp. 437-441, October 1966.

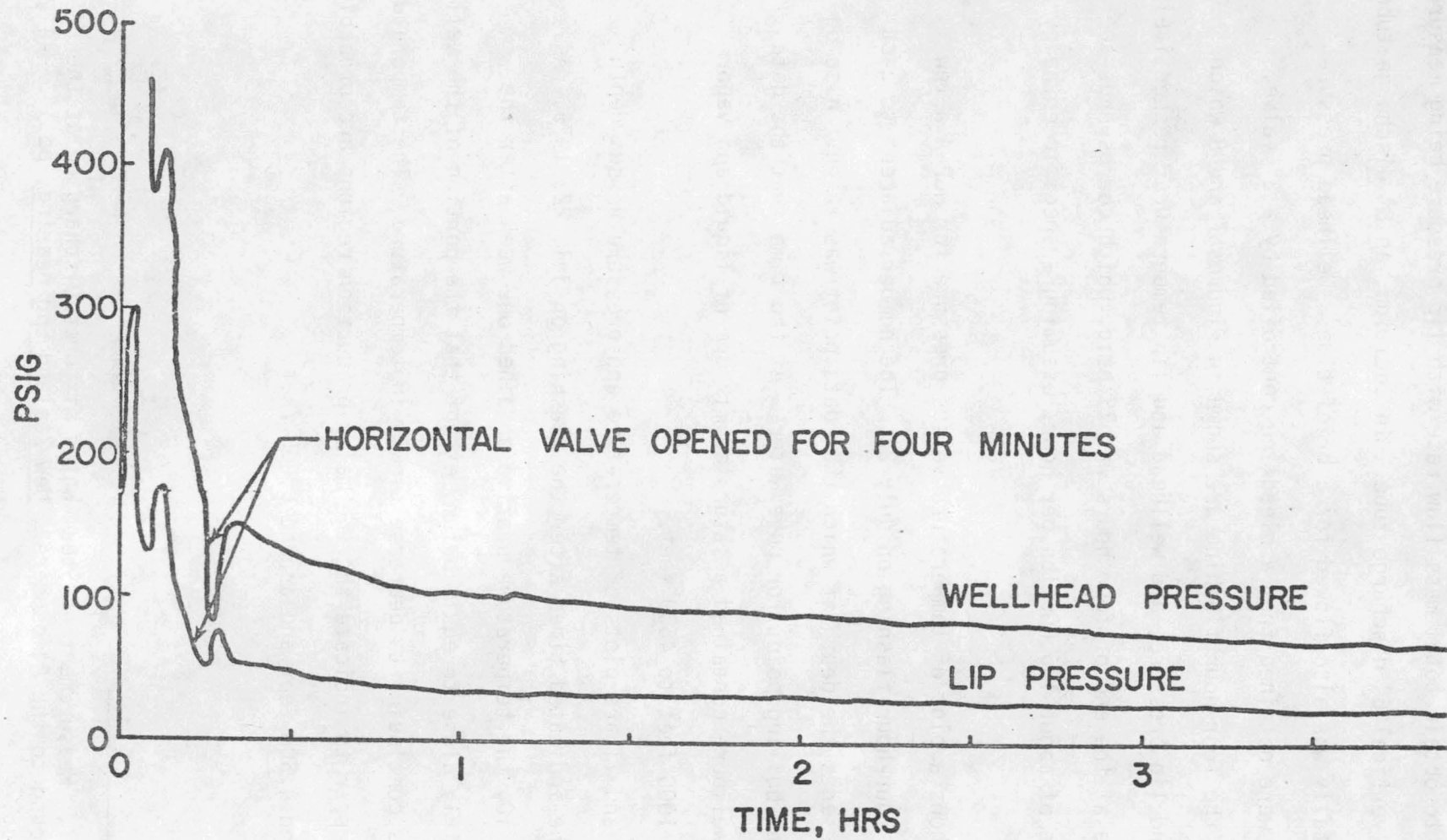

Figure 7. HGP-A Flow Test, July 22, 1976. Variation in Wellhead & Lip Pressure with Time.

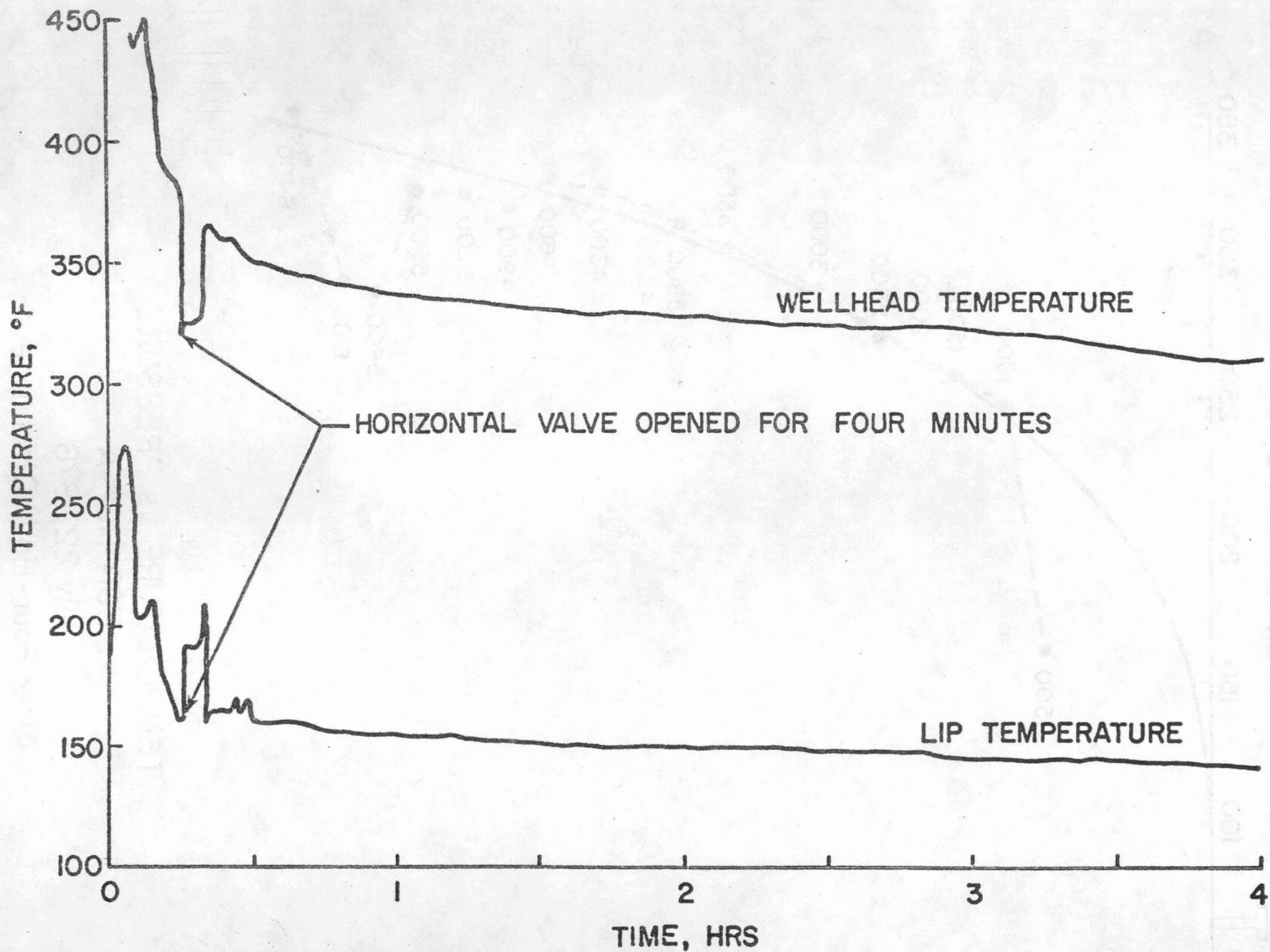

Figure 8. HGP-A Flow Test, July 22, 1976. Variation in Wellhead & Lip Temperature with Time.

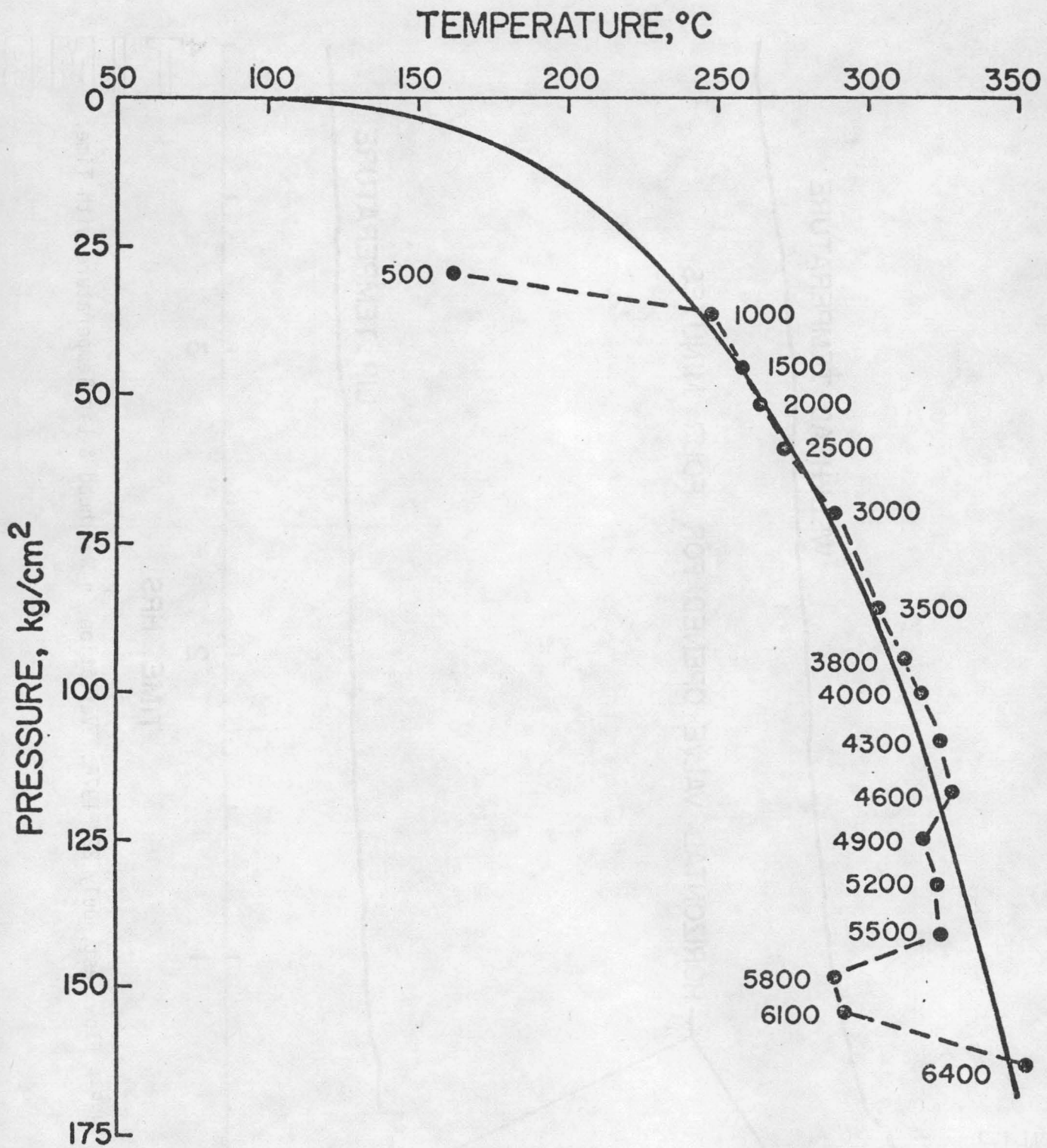
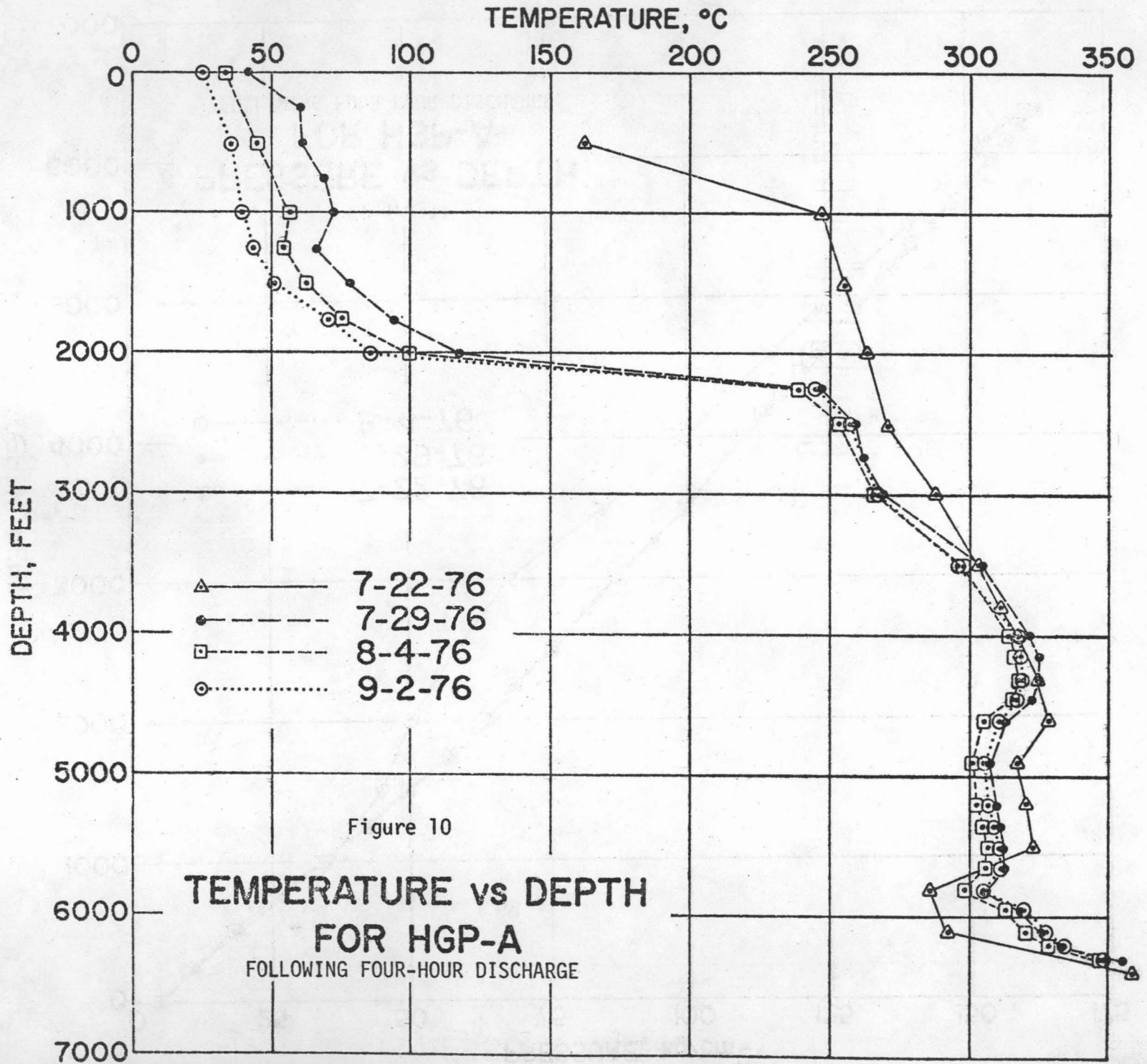

Figure 9
 TEMPERATURE vs PRESSURE
 FOR HGP-A
 July 22, 1976
 After Four-Hour Discharge



PRESSURE, kg/cm²

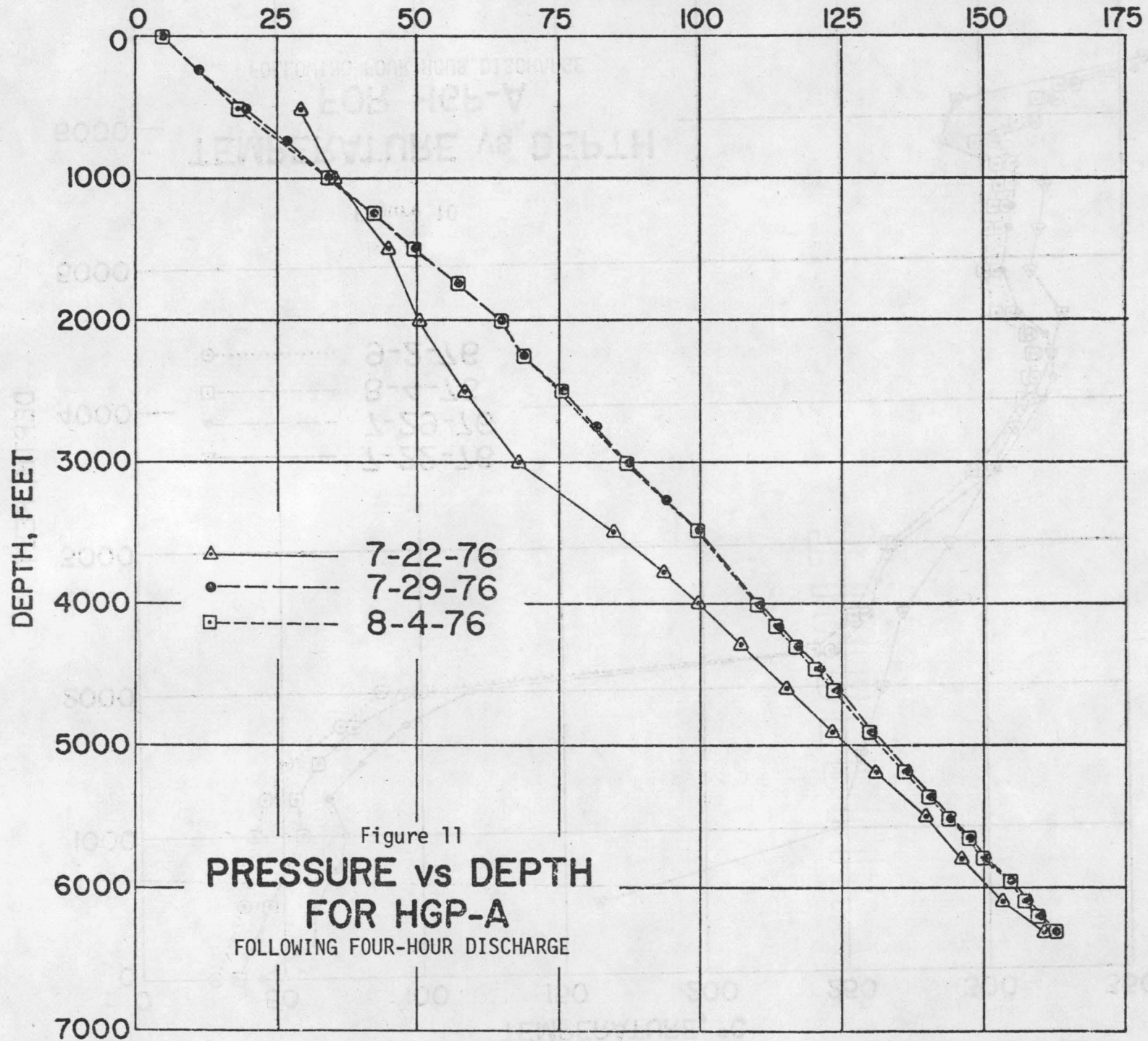

Figure 11
**PRESSURE vs DEPTH
FOR HGP-A**
FOLLOWING FOUR-HOUR DISCHARGE

SUMMARY OF PRODUCTION FLOW TESTS

November Flow Test (11/3/76 - 11/17/76)

Following the installation of the silencer/separator unit (Figure 12), which basically provides for some fluid discharge noise silencing, separation of steam and water, and measurement of total mass flow and liquid flow, a two-week discharge was run to test the equipment and also to determine whether the well would produce for that length of time. Test data on well performance were recorded and are plotted in Figures 13 to 15, which give wellhead pressure, wellhead temperature, and lip pressure as functions of time. As shown, following an initial transient flow during which the wellbore was discharged, the pressures settled into an expected straight-line variation on the semi-log plot. The water flow as measured by the height of the water flowing over the weir notch remained essentially constant at 24,000 pounds per hour throughout, except for the initial period.

Figure 16 is a plot of total mass flow rate as derived using the Russell James method. At the end of the two-week period, total mass flow rate was 74,000 pounds per hour. Figures 17 to 20 give steam flow rate, enthalpy, steam quality, and thermal power as function of time.

Figure 12

HAWAII GEOTHERMAL PROJECT
FLOW TEST EQUIPMENT AND INSTRUMENTATION

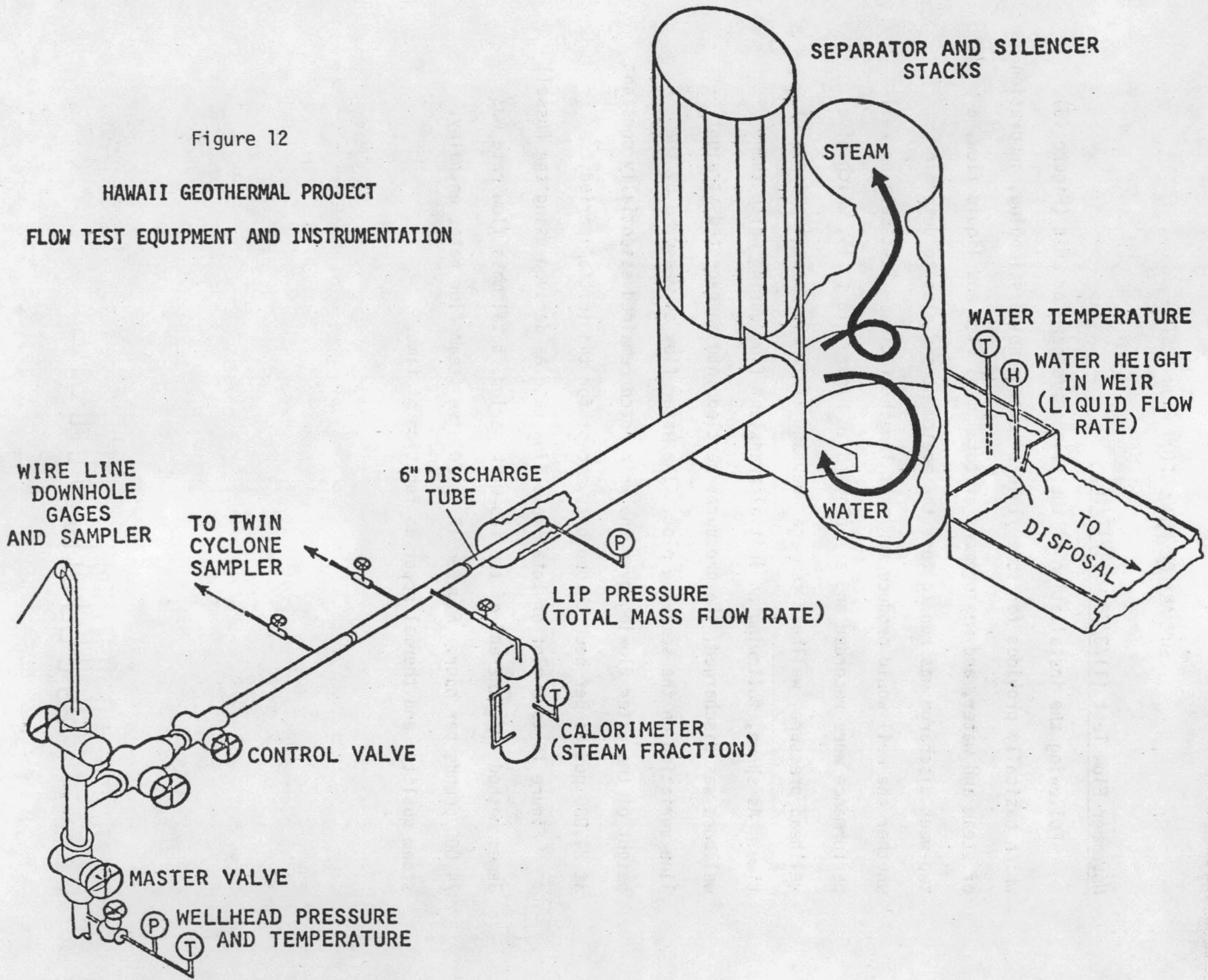

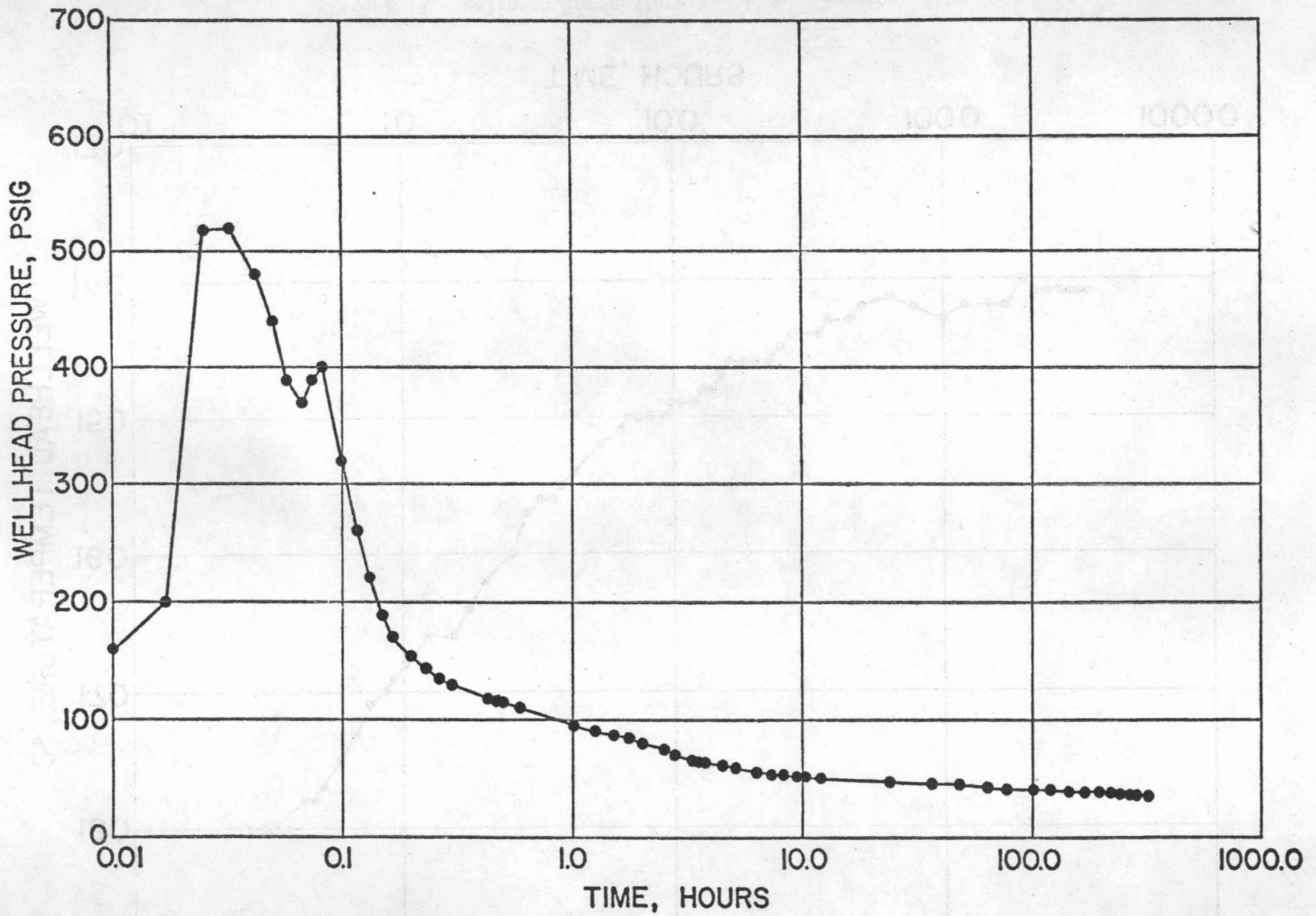

Figure 13. Wellhead Pressure vs. Time. November Flow Test.

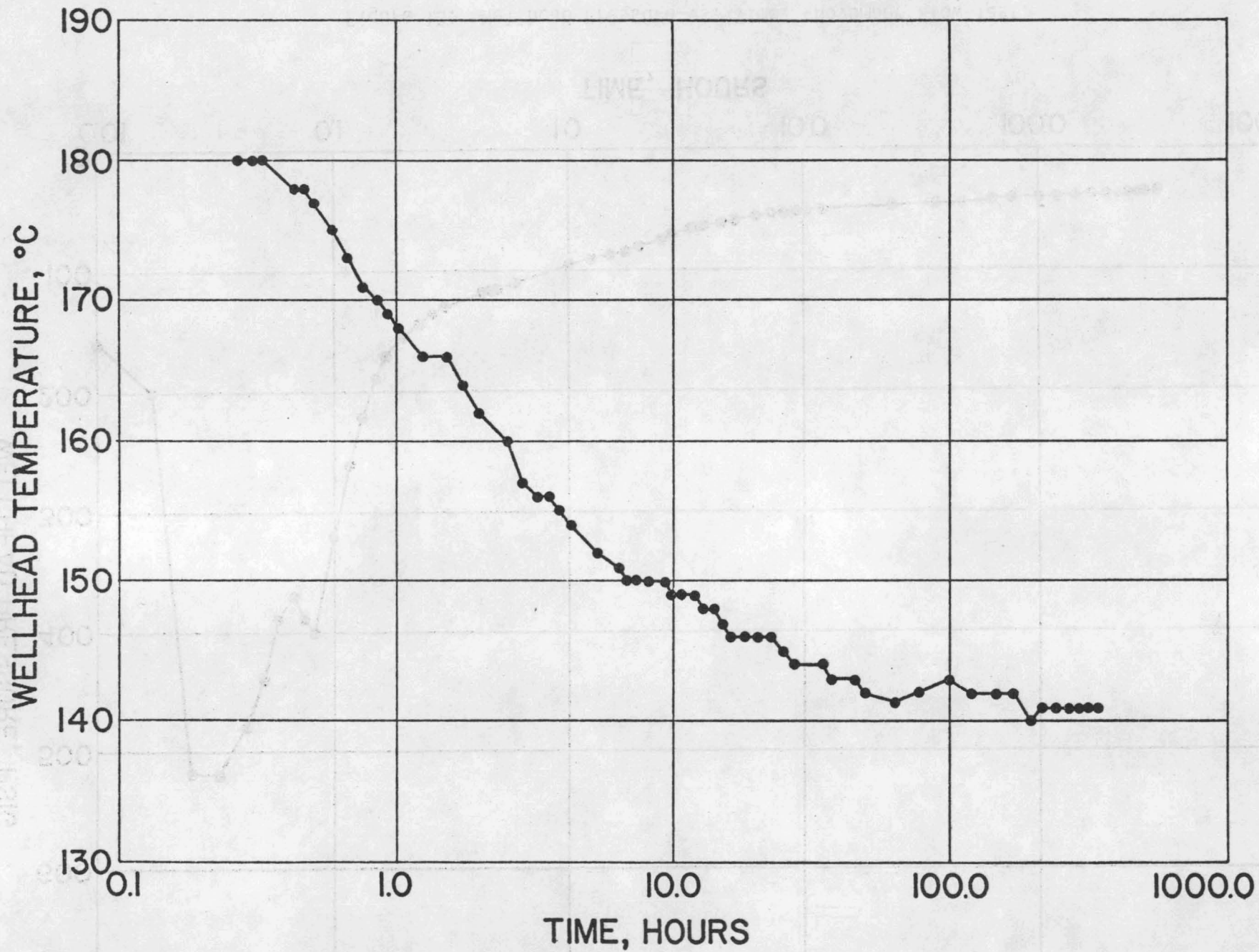

Figure 14. Wellhead Temperature vs. Time. November Flow Test.

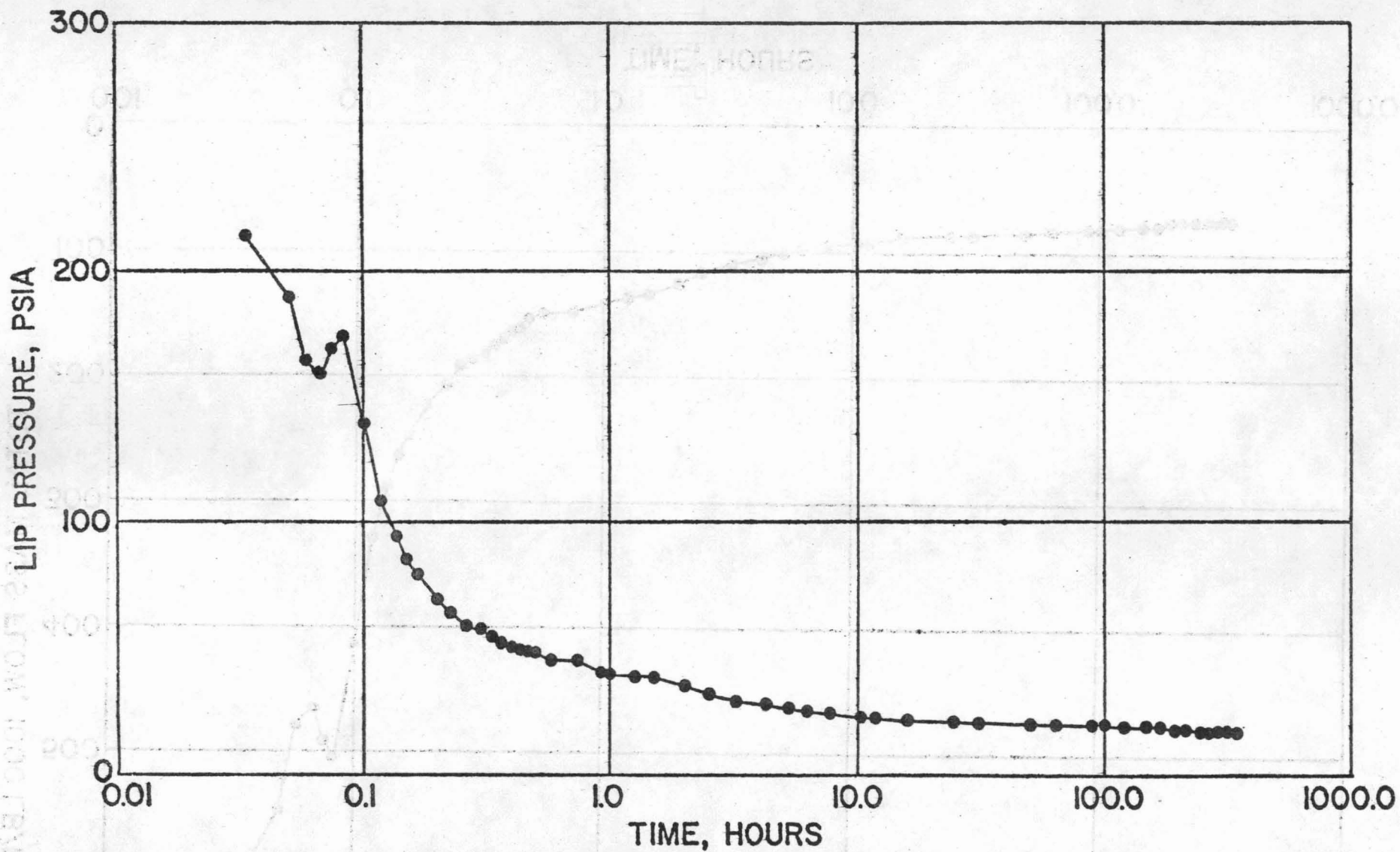

Figure 15. Lip Pressure vs. Time. November Flow Test.

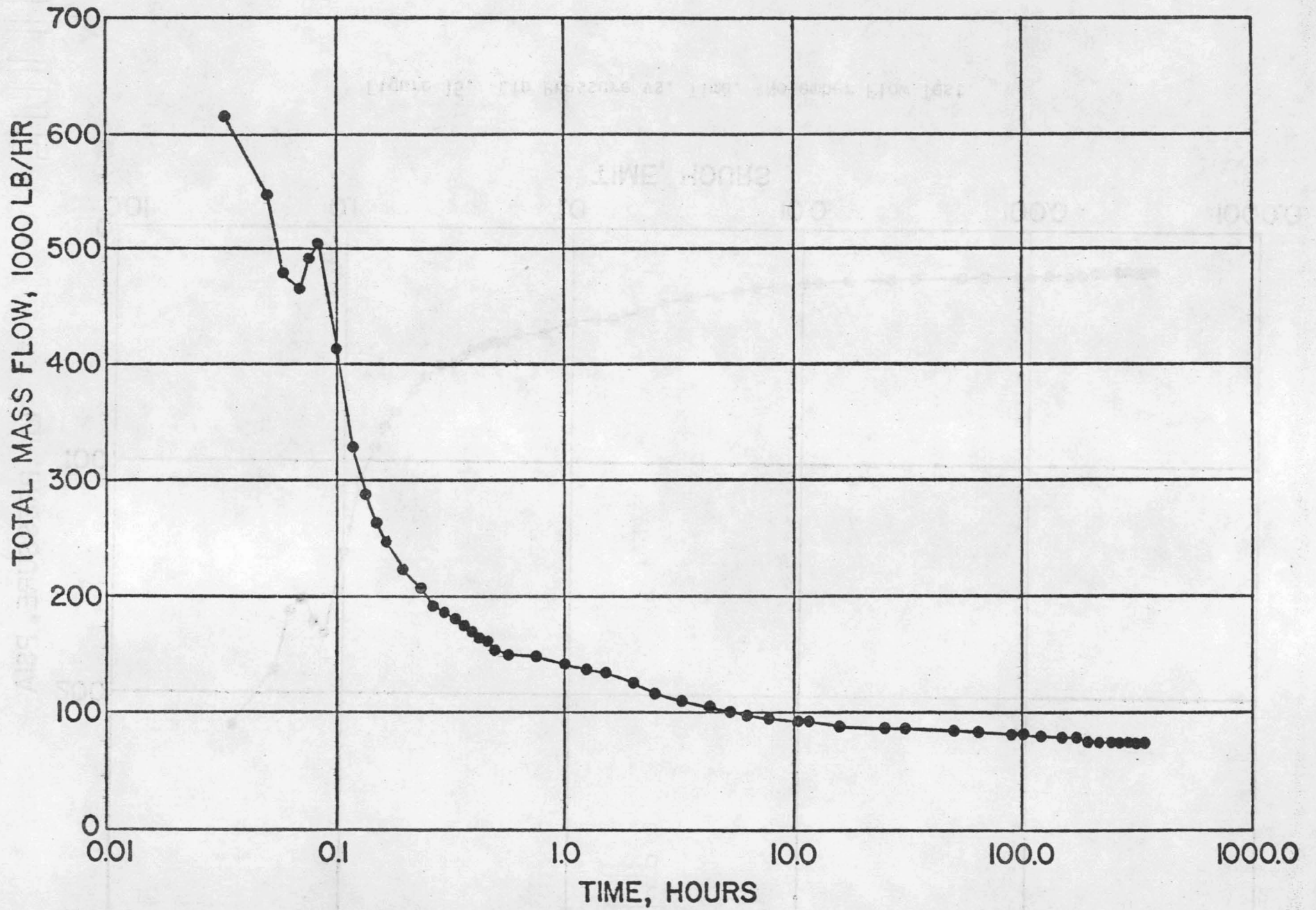

Figure 16. Total Mass Flow Rate vs. Time. November Flow Test.

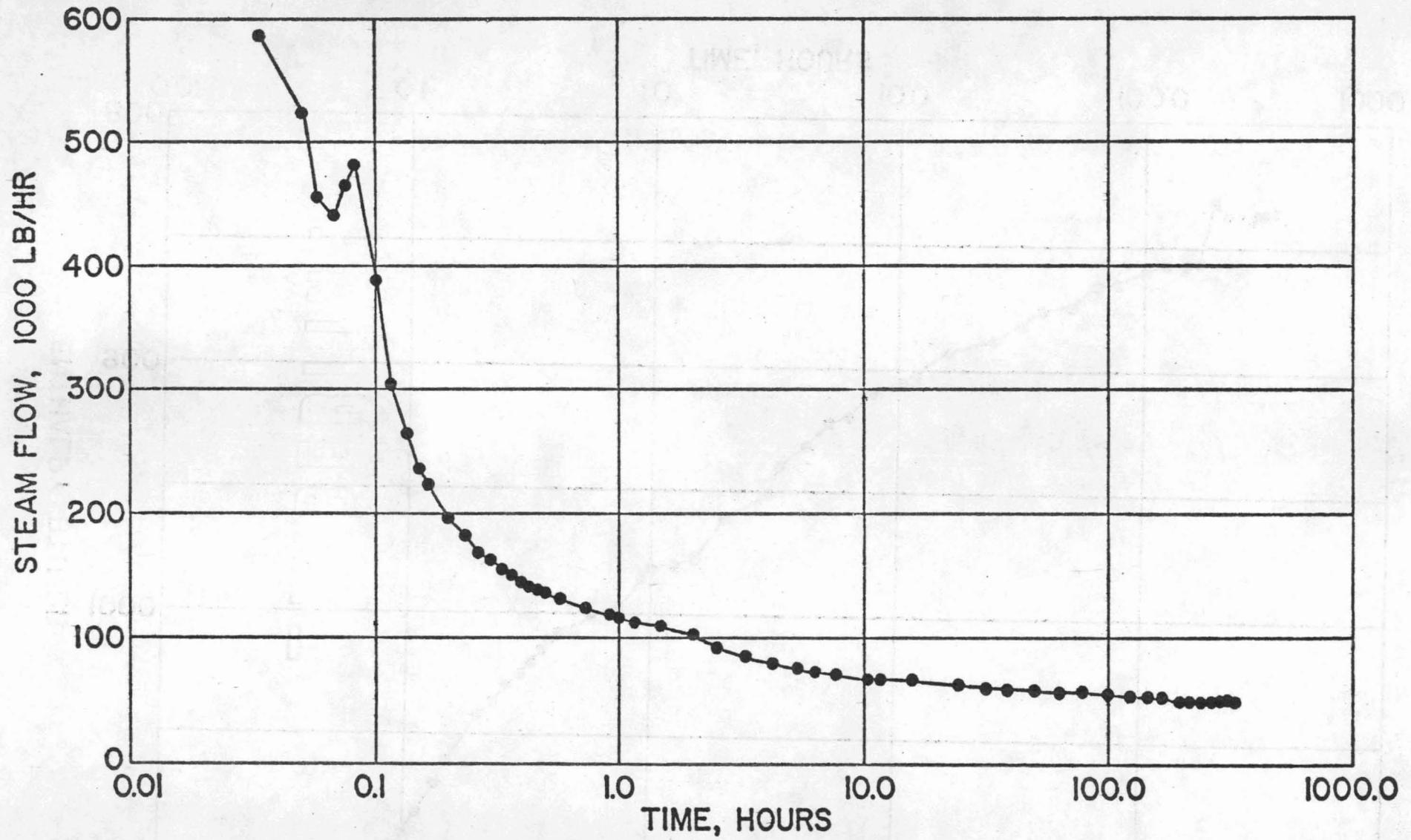

Figure 17. Steam Flow Rate vs. Time. November Flow Test.

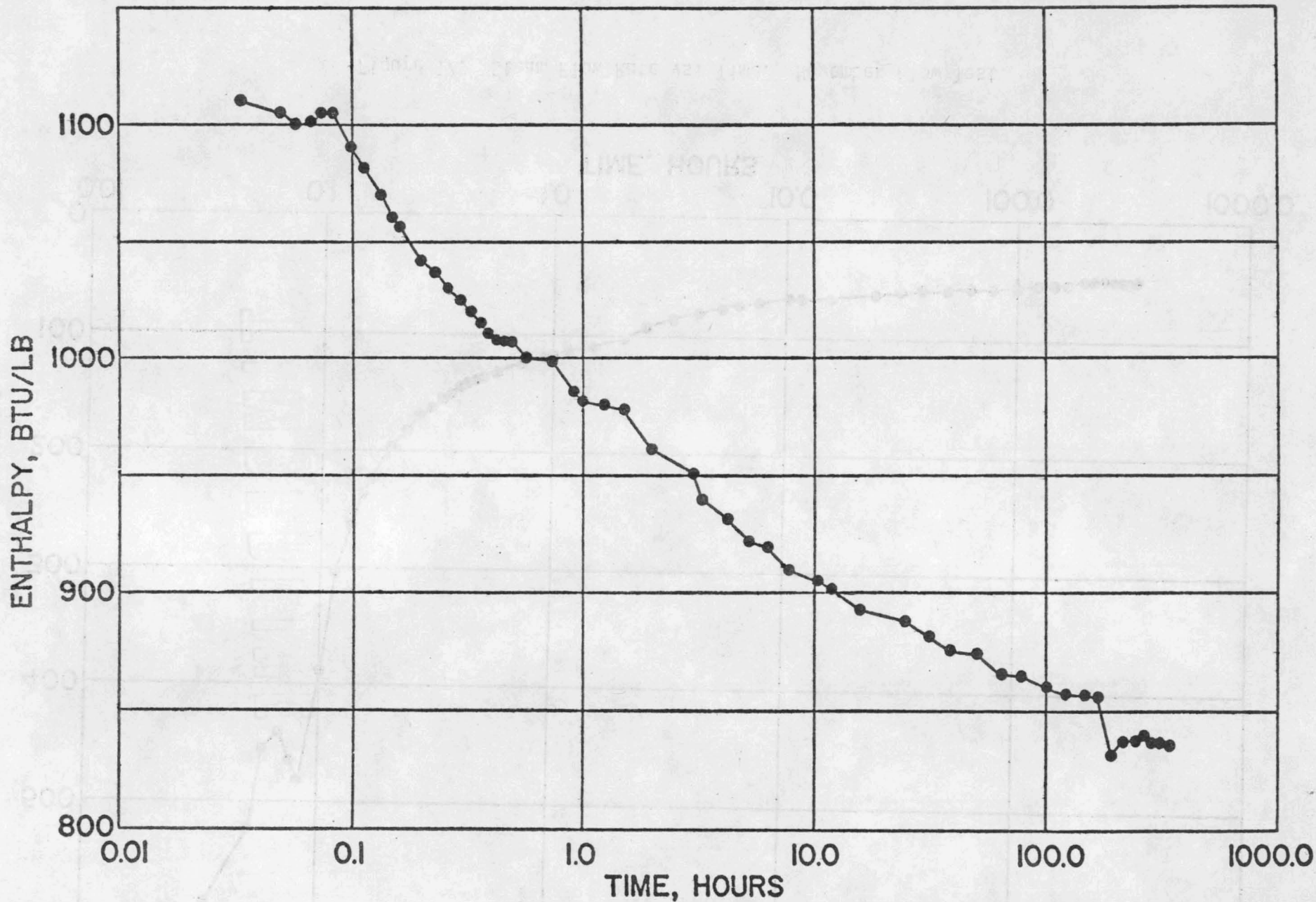

Figure 18. Enthalpy of Discharge vs. Time. November Flow Test.

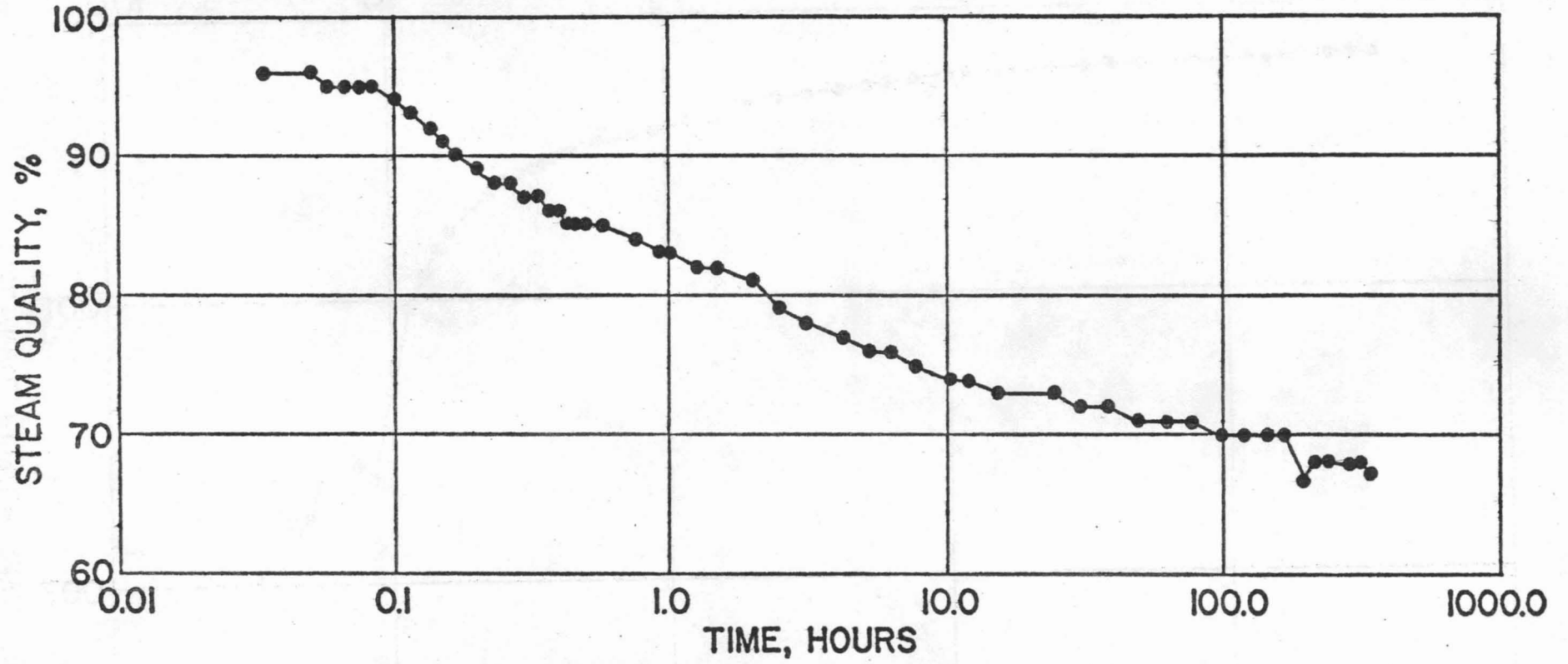

Figure 19. Steam Quality vs. Time. November Flow Test.

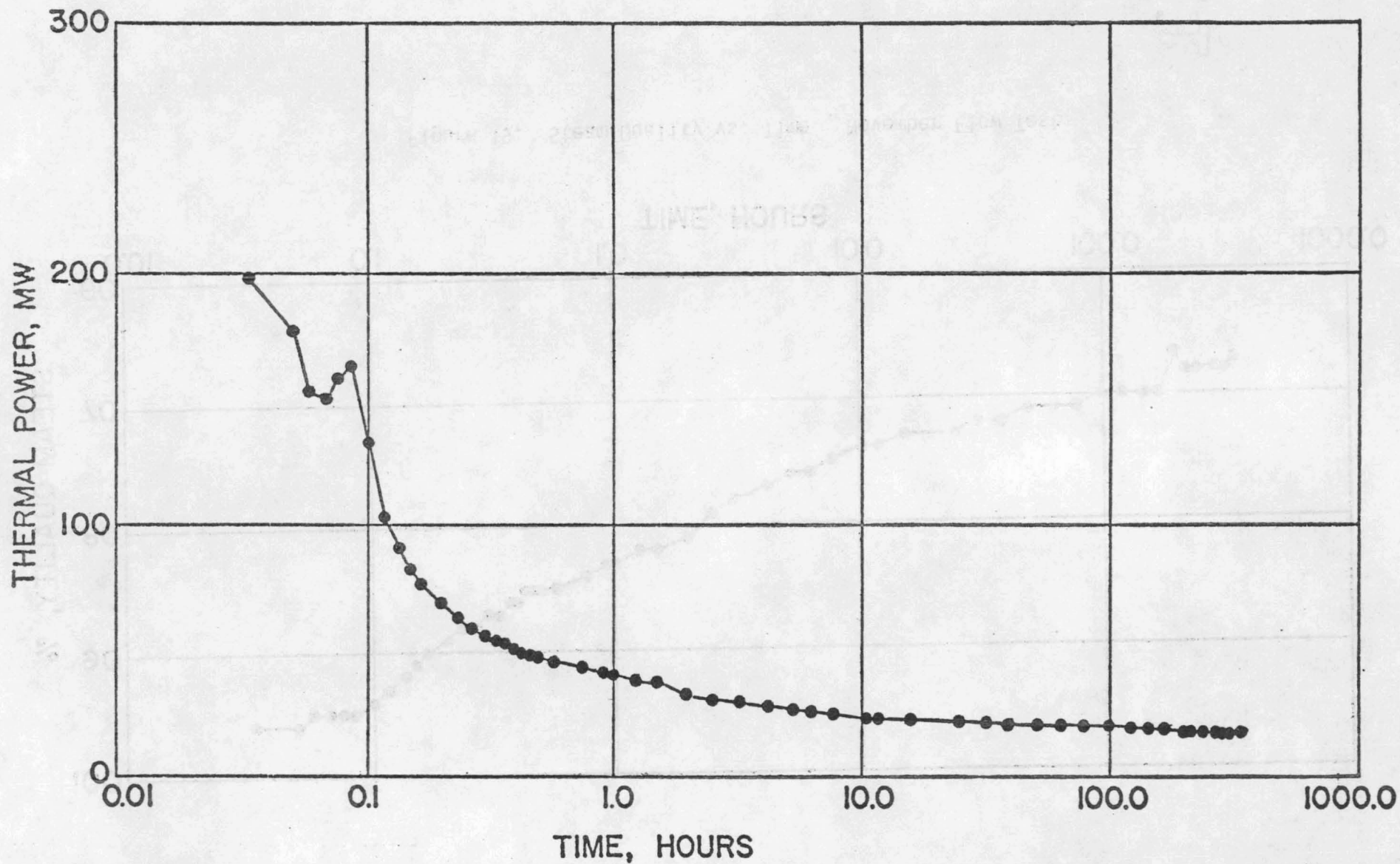

Figure 20. Thermal Power vs. Time. November Flow Test.

December Flow Test (12/12/76 - 12/19/76)

The main purpose of this flow test was to obtain temperature and pressure profile measurements while the well was discharging. While retrieving the probe from the wellhead, the wireline was cut accidentally and the probe was lost downhole.

While rental recorder instruments were being delivered to the site, the flow was throttled with the horizontal valve to a lip pressure measurement of about 4 psig. The wellhead pressure and wellhead temperature rose and leveled off from 46 psig and 145°C to 181 psig and 194°C, respectively, with little change in the total mass flow rate.

With the arrival of the instruments, temperature and pressure measurements were made downhole, with the well flashing. A check of the data showed that the temperature at wellhead measured by the Kuster temperature probe within the wellhead matched that measured by the temperature gauge mounted externally. However, there was a discrepancy between pressures measured by the Kuster probe located internally and the dial gauge mounted externally. A careful check of the Kuster pressure probe revealed the possibility of a partial leak of vapor into the outer portion of the bourdon tubes. Following this experience, extra precautions have been taken with all gaskets, O-rings, and screw thread lubricants and sealants.

January/February Flow Test (1/26/77 - 2/11/77)

A series of tests to determine HGP-A output parameters under throttled flow conditions was completed during this test period. Throttling was accomplished by placing orifice plates of various sizes in the 8-inch diameter section of the discharge line. The results are summarized in Table 3. There is a substantial increase in wellhead pressure from 51 to 375 psig as the flow rate was reduced from 101 Klb/hr (100%) to 76 Klb/hr (75%).

The electrical power output possible from these flow conditions was calculated, assuming a conversion efficiency of 75% as the steam expands from wellhead pressure to a back pressure of four inches of mercury. There is a broad power output maximum of 3.5 to 3.1 MW(e) over the range of wellhead pressure from 100 to 300 psig. This range will allow a wide latitude in the design of a wellhead generator system. While more power can be extracted per pound of higher pressure system, this advantage must be balanced against the more expensive equipment (pipe, valves, separator) that higher pressure systems require.

Temperature and pressure profiles in the wellbore taken during the throttled flow test are shown in Figures 21 and 22. As in previous flow tests, these profiles indicate that the fluid in the wellbore is at saturation conditions with a mixture of water and steam flowing up through the wellhead. As expected when the smaller orifice plates are in, the temperature and pressure both increase in the wellbore.

Temperature recovery of the well after shut-in is depicted in Figure 23. This figure shows temperature profiles (a) while the well is discharging at 76 Klb/hr one day prior to shut-in, (b) 8 days after shut-in, (c) 14 days after shut-in, and (d) 25 days after shut-in. The region below 3000 feet depth shows a warming trend after being shut-in, with the exception of the anomalous point at 4300 feet, while the upper region shows an initial cooling period followed by warming.

TABLE 3

THROTTLED FLOW DATA 1/26/77 - 2/10/77

<u>ORIFICE SIZE (INCHES)</u>	<u>TOTAL MASS FLOW RATE (KLB/HR)</u>	<u>STEAM FLOW RATE (KLB/HR)</u>	<u>STEAM QUALITY (%)</u>	<u>WELLHEAD PRESSURE (PSIG)</u>	<u>WELLHEAD TEMP. (°F)</u>	<u>POSSIBLE ELECTRICAL POWER OUTPUT (MWE)</u>
8	101	64	64	51	295	3.3
6	99	65	66	54	300	3.4
4	93	57	64	100	338	3.5
3	89	54	60	165	372	3.5
2-1/2	84	48	57	237	401	3.3
2	81	43	53	293	419	3.1
1-3/4	76	39	52	375	439	3.0

4/07/77

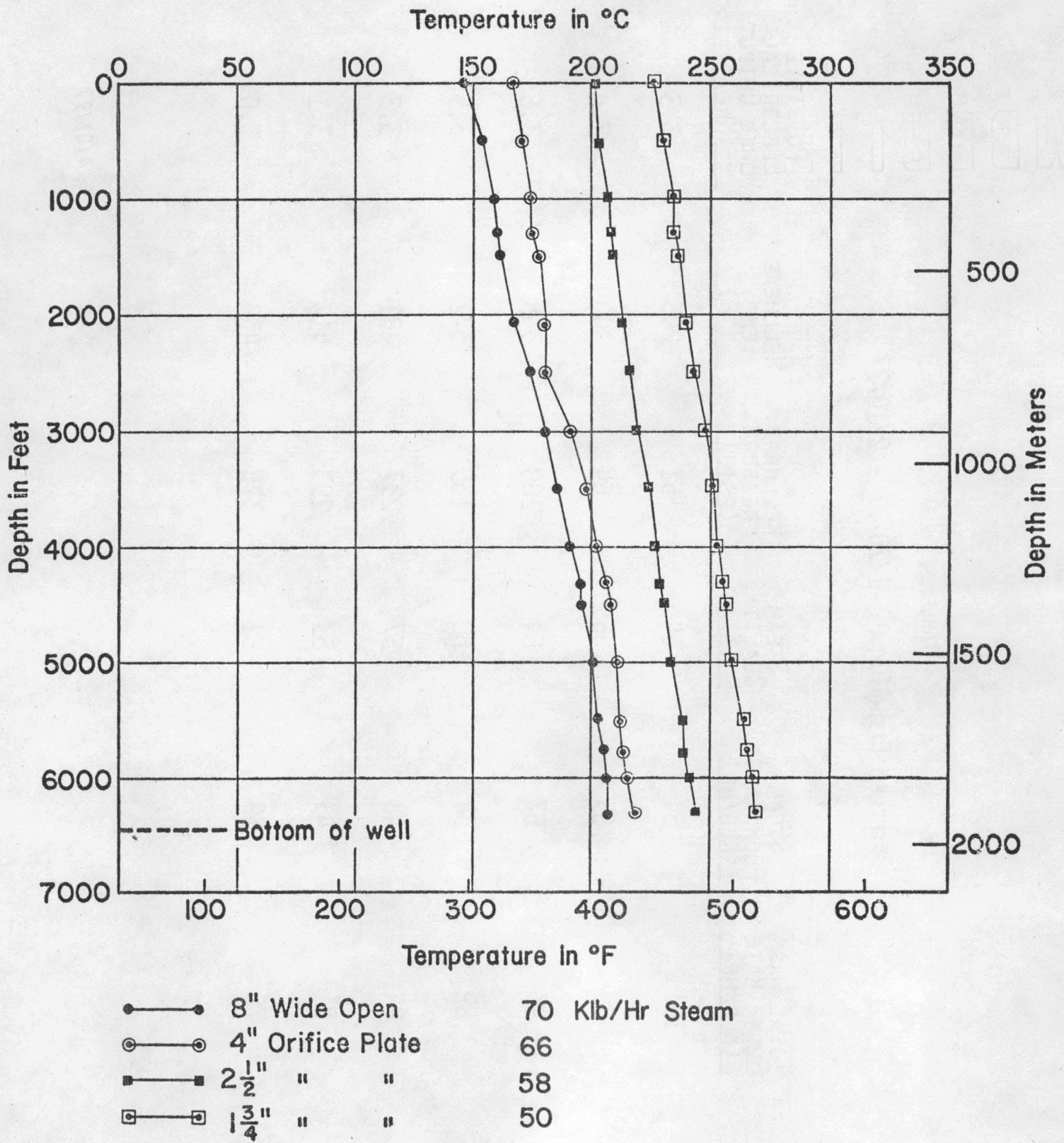
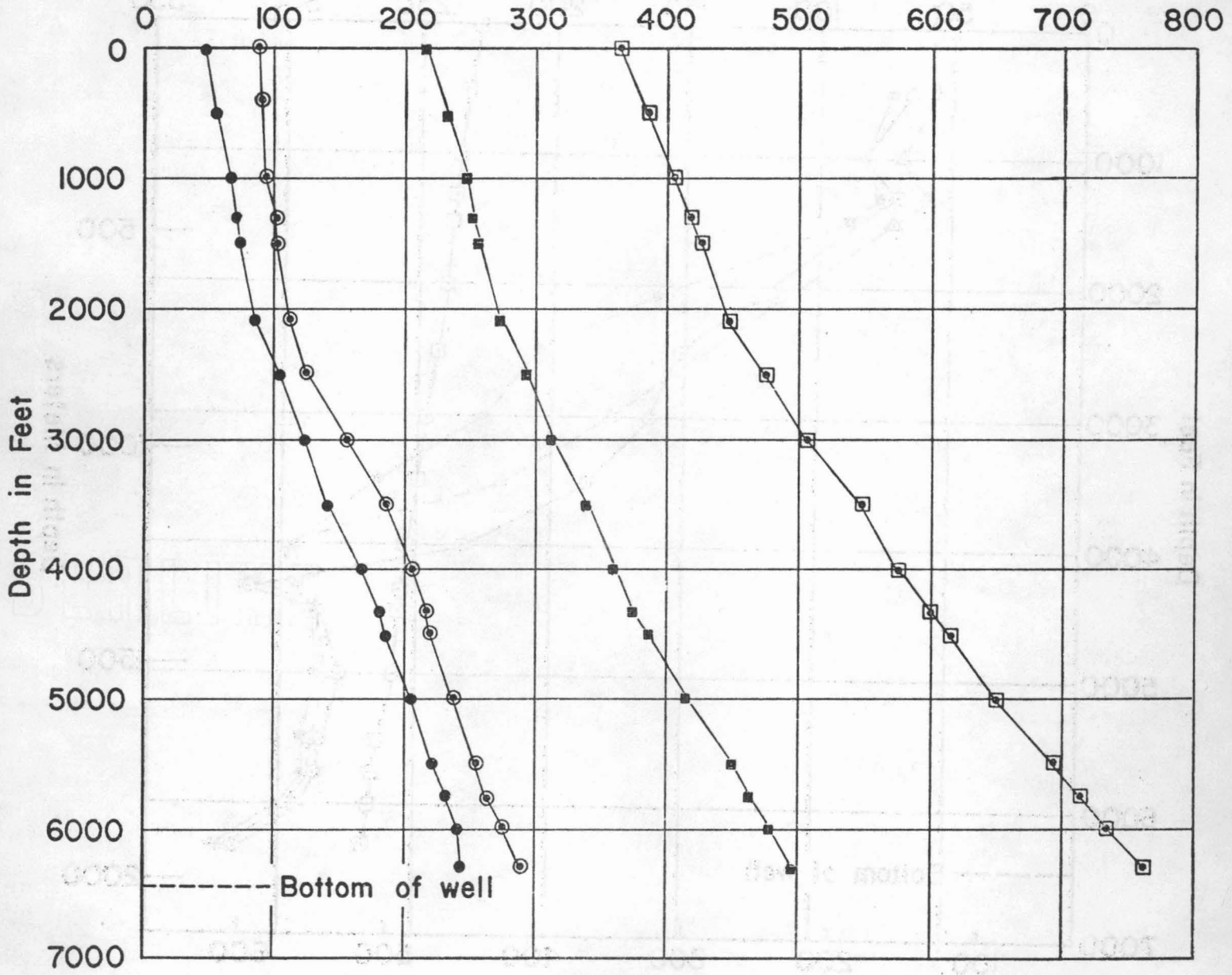

Figure 21. Temperature Profiles During Flashing
January/February Flow Test

Pressure in Psig



- 8" Wide Open 70 Klb/Hr Steam
- 4" Orifice Plate 66
- 2 1/2" " " 58
- 1 3/4" " " 50

Figure 22. Pressure Profiles During Flashing
January/February Flow Test

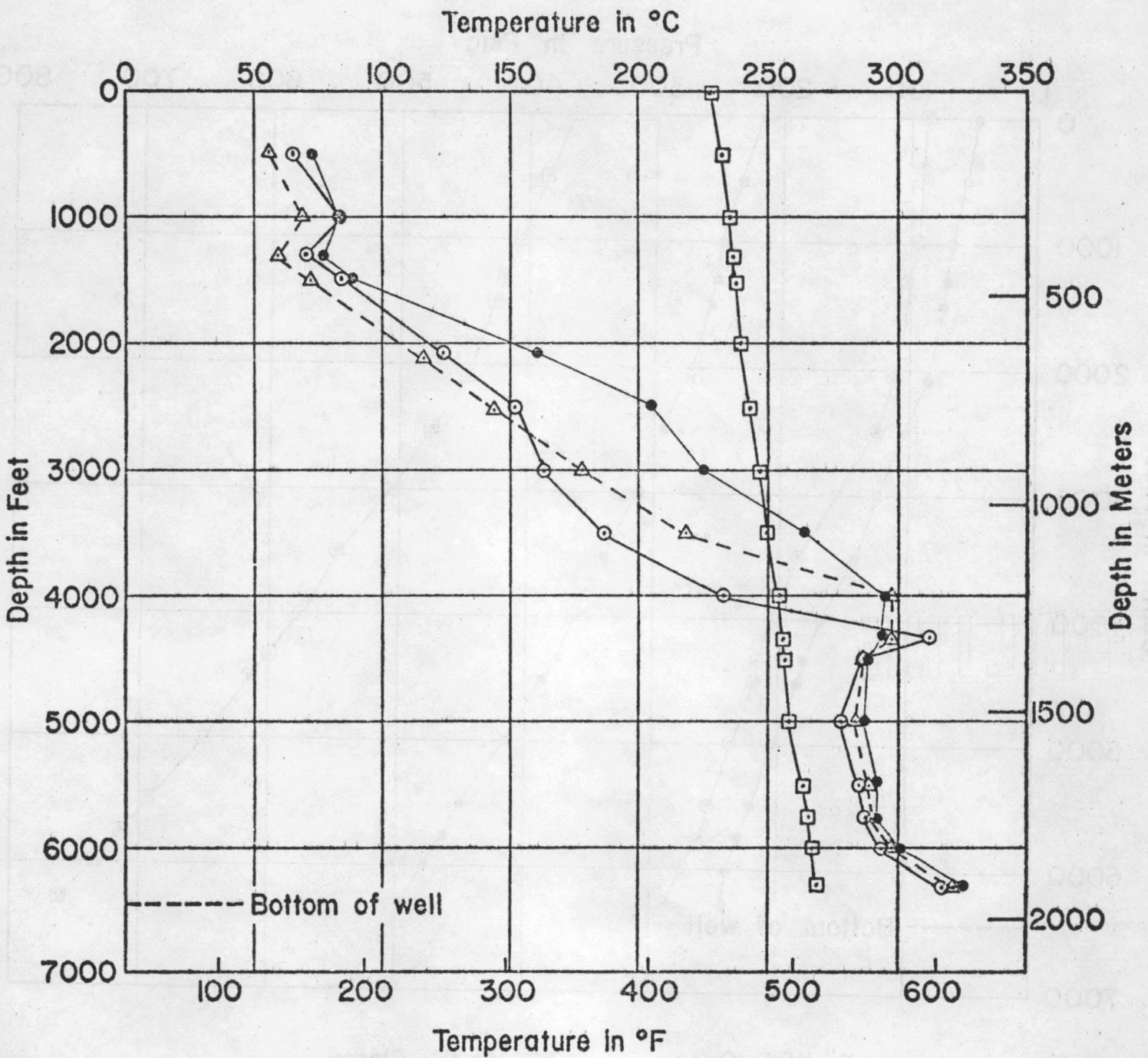

- 2/10/77 Well Discharging with 1 3/4" Orifice Plate
- 2/19/77 8 Days after Shut-in
- △---△ 2/25/77 14 Days after Shut-in
- 3/8/77 25 Days after Shut-in

Figure 23. Temperature Recovery after January/February Flow Test

March-May (3/28/77 - 5/9/77)

In order to clean the wellbore of mud, cuttings, and debris, the well was surged once a day, for one hour, beginning March 21, 1977 to March 28, 1977. Then the well was flashed for 25 hours with the discharge line fully open. Following this, a three-inch orifice plate was inserted into the discharge line and the well flowed for 42 days before being shut in. Figures 24 to 31 display the data obtained during this production test. If the data points from this test are expanded linearly on the plots of Figures 24 to 31, then the projections given in Table 4 result.

During the flashing, detailed temperature and pressure profiles were taken at 100 foot intervals along the wellbore. This information is presented in Figures 32 and 33. As expected temperature and pressure decreased with time decreasing total mass flow rate.

Table 5 presents a comparison of parameters for each flow test after 25 hours of discharge. Flow rates have increased steadily with each test as evidenced by a 37% increase in total mass flow rate and 25% increase in steam flow rate between the November and March test periods.

Because several complaints were received of the hydrogen sulfide odor and its possible adverse health effects, an anemometer to monitor the wind's speed and direction was placed at the wellsite. A questionnaire was distributed to nearby residents asking for dates, times, and severity of odor. In addition, water samples were obtained at the wellsite and homesites downwind of the site to check the hydrogen sulfide and sulfuric acid concentrations. Of 34 residents, only five responded with reactions ranging from no discomfort (only unpleasant odor) to nausea and burning feeling in the eyes.

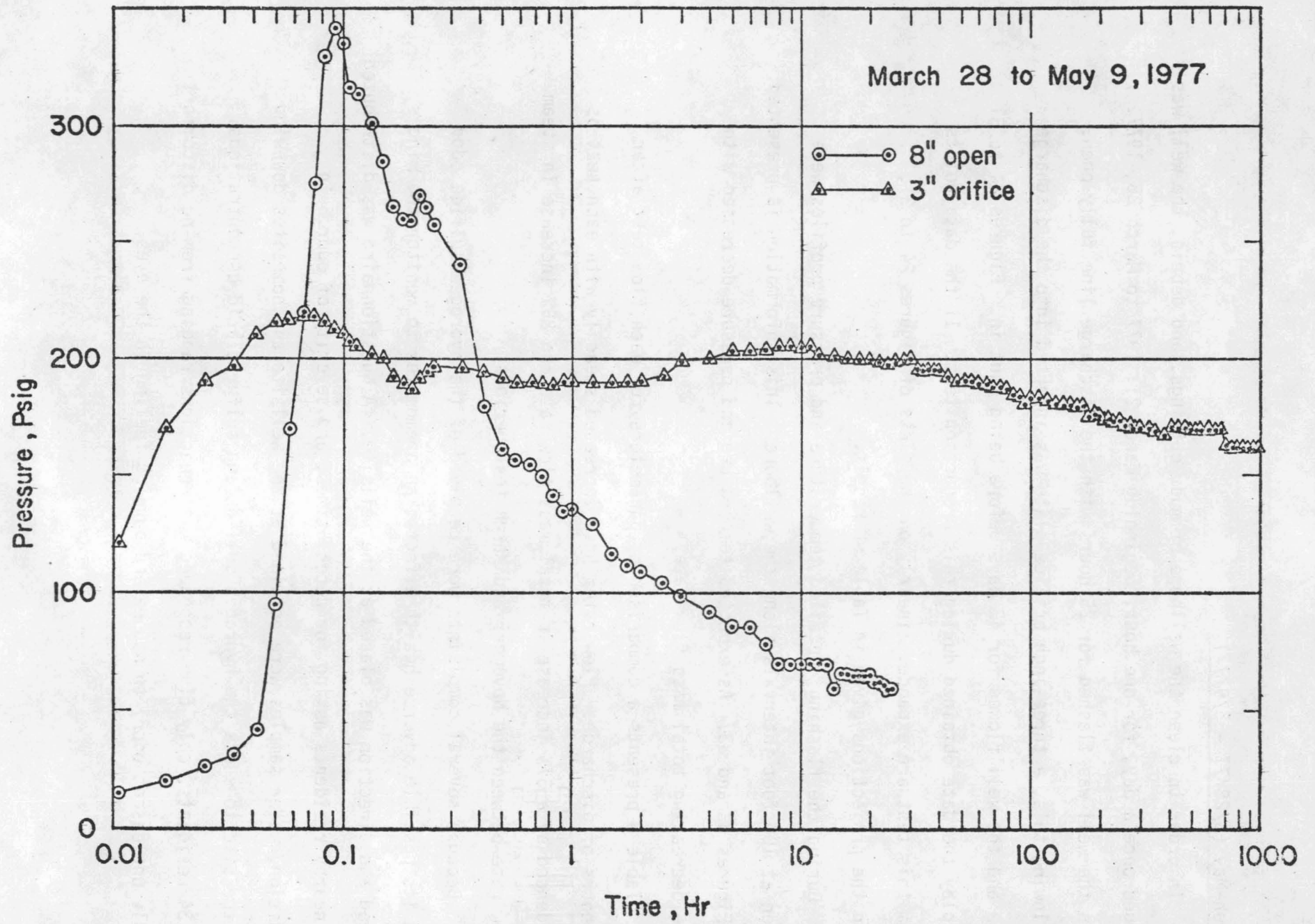

Figure 24. Wellhead Pressure during March-May Flow Test

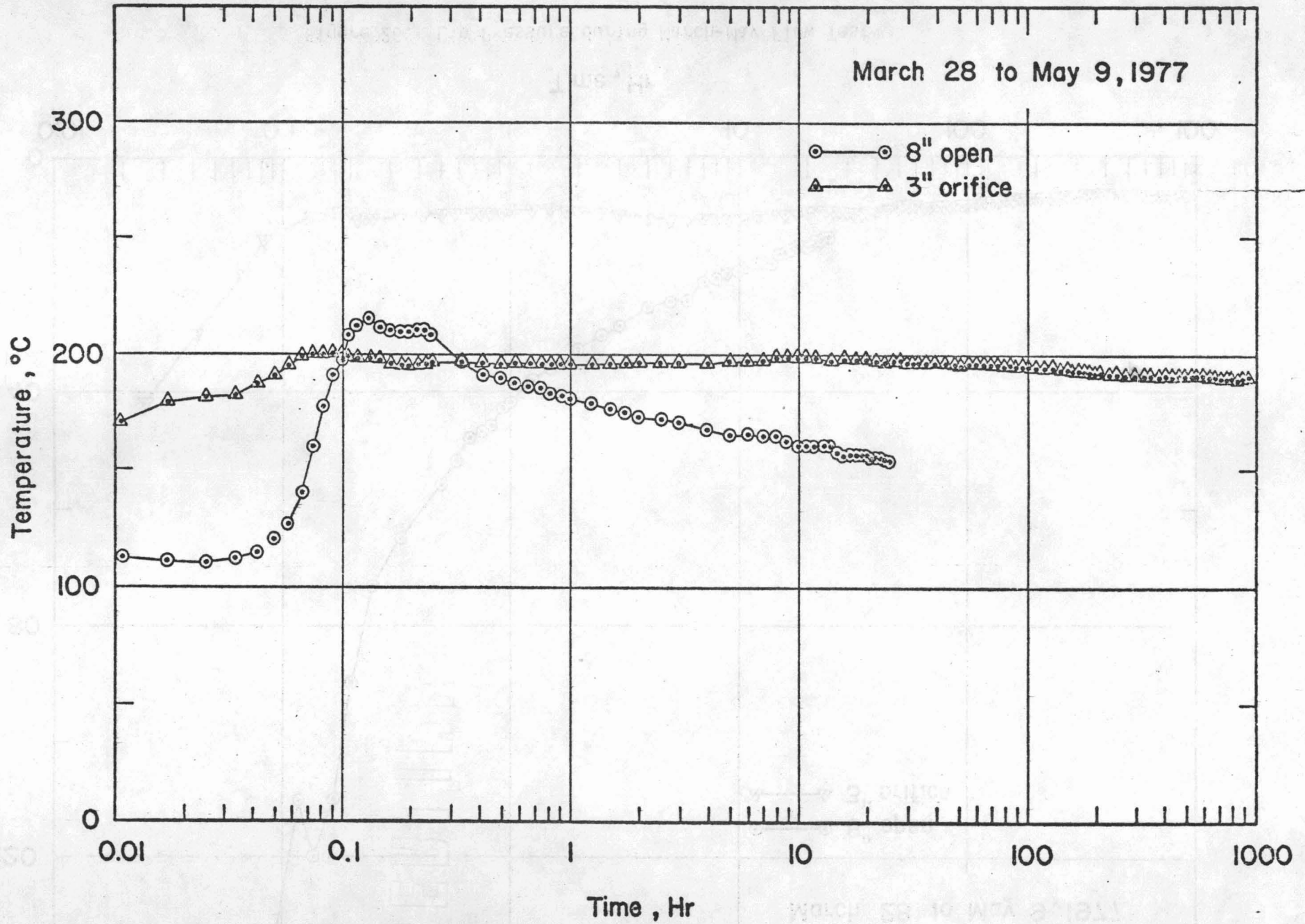

Figure 25. Wellhead Temperature during March-May Flow Test

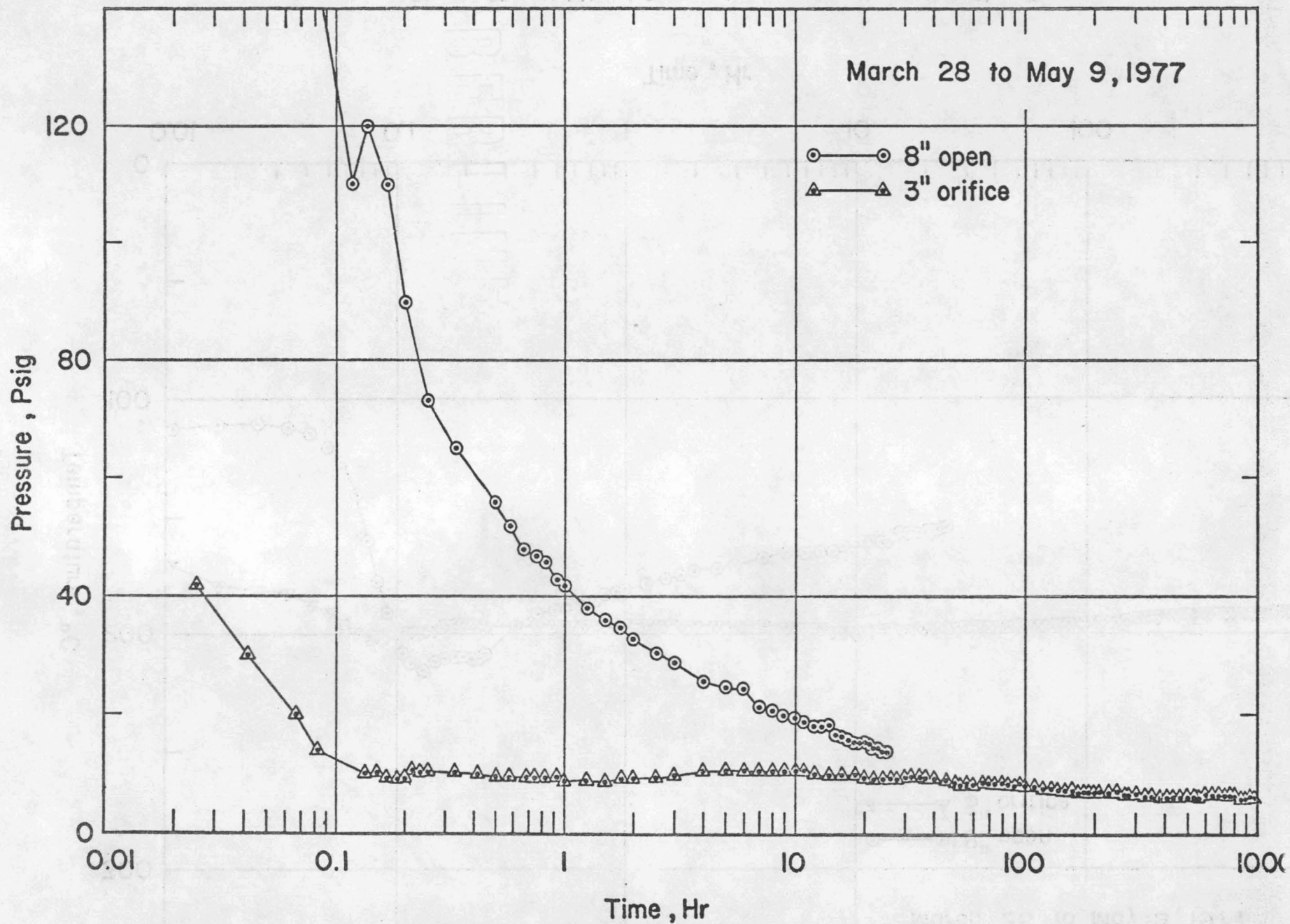

Figure 26. Lip Pressure during March-May Flow Test

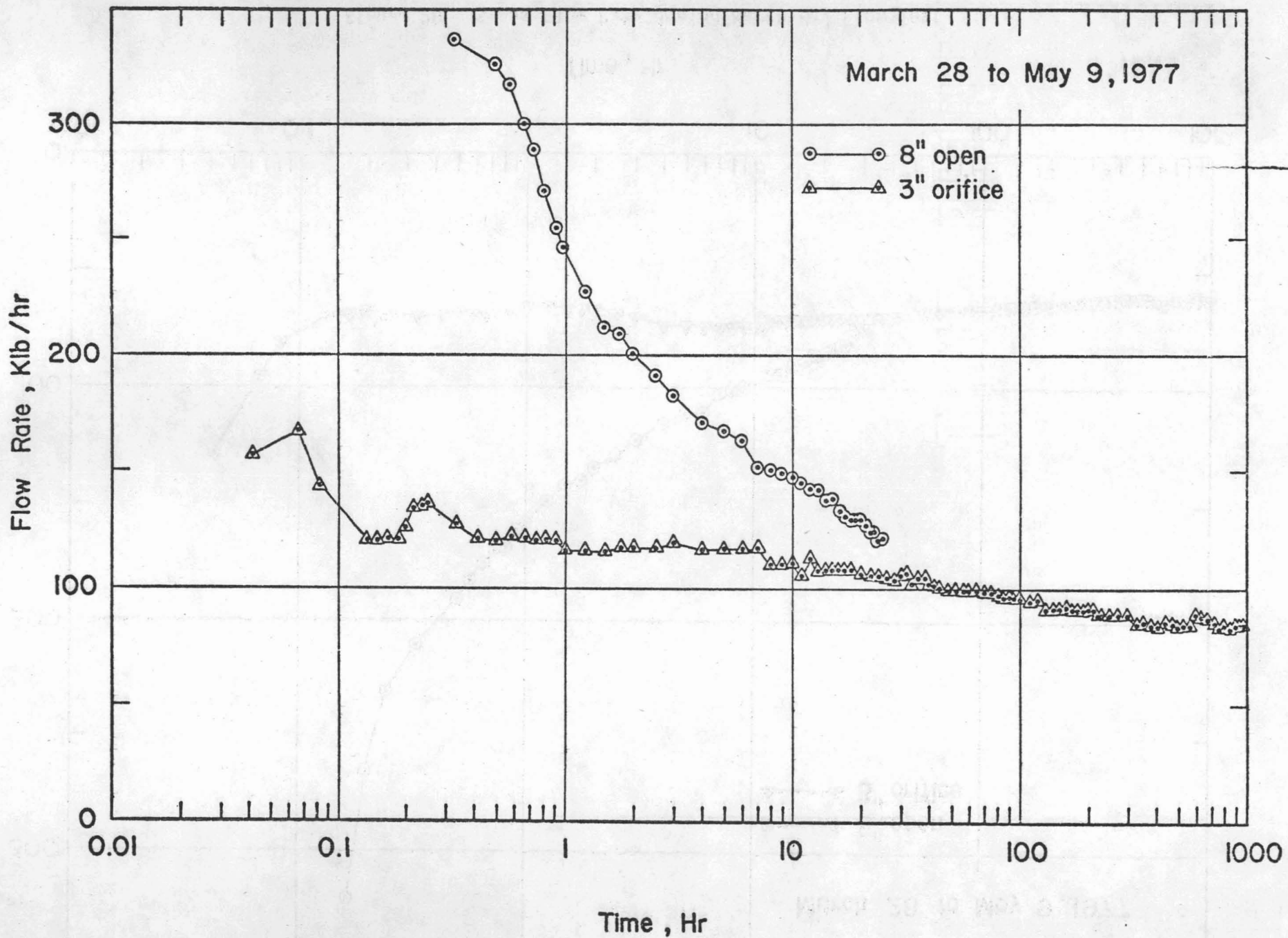

Figure 27. Total Mass Flow Rate during March-May Flow Test

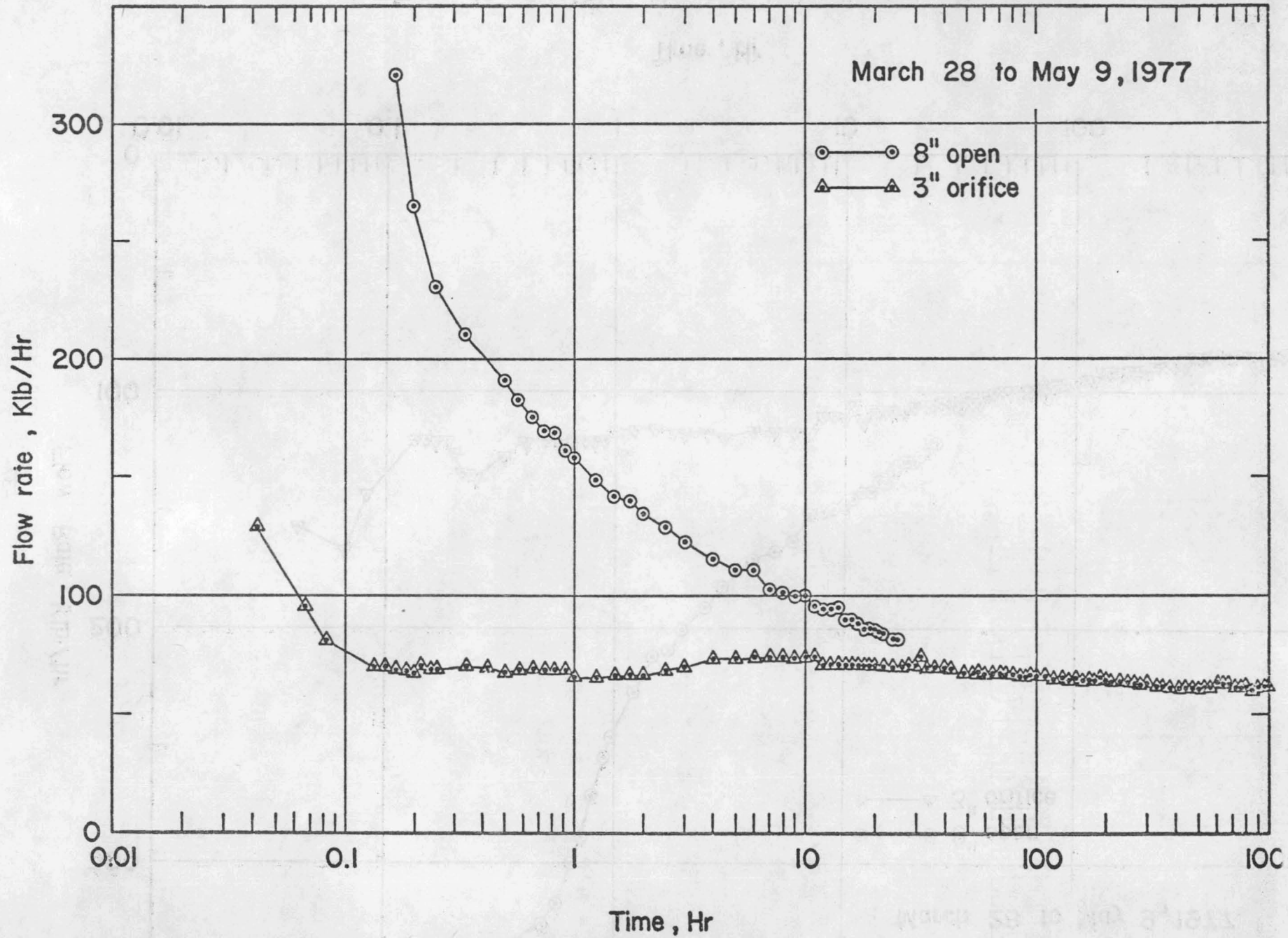

Figure 28. Steam Flow Rate during March-May Flow Test

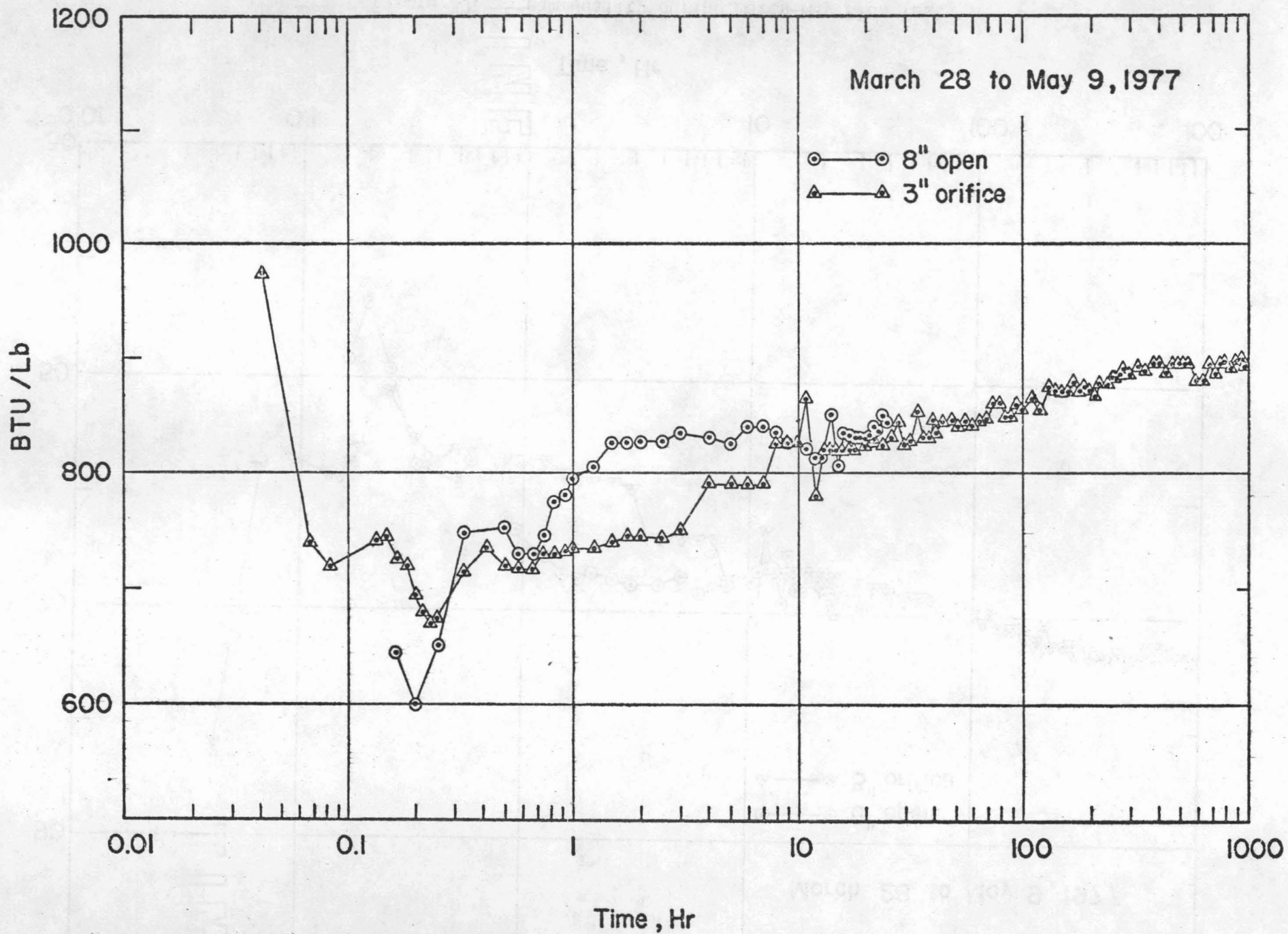

Figure 29. Enthalpy of Discharge during March-May Flow Test

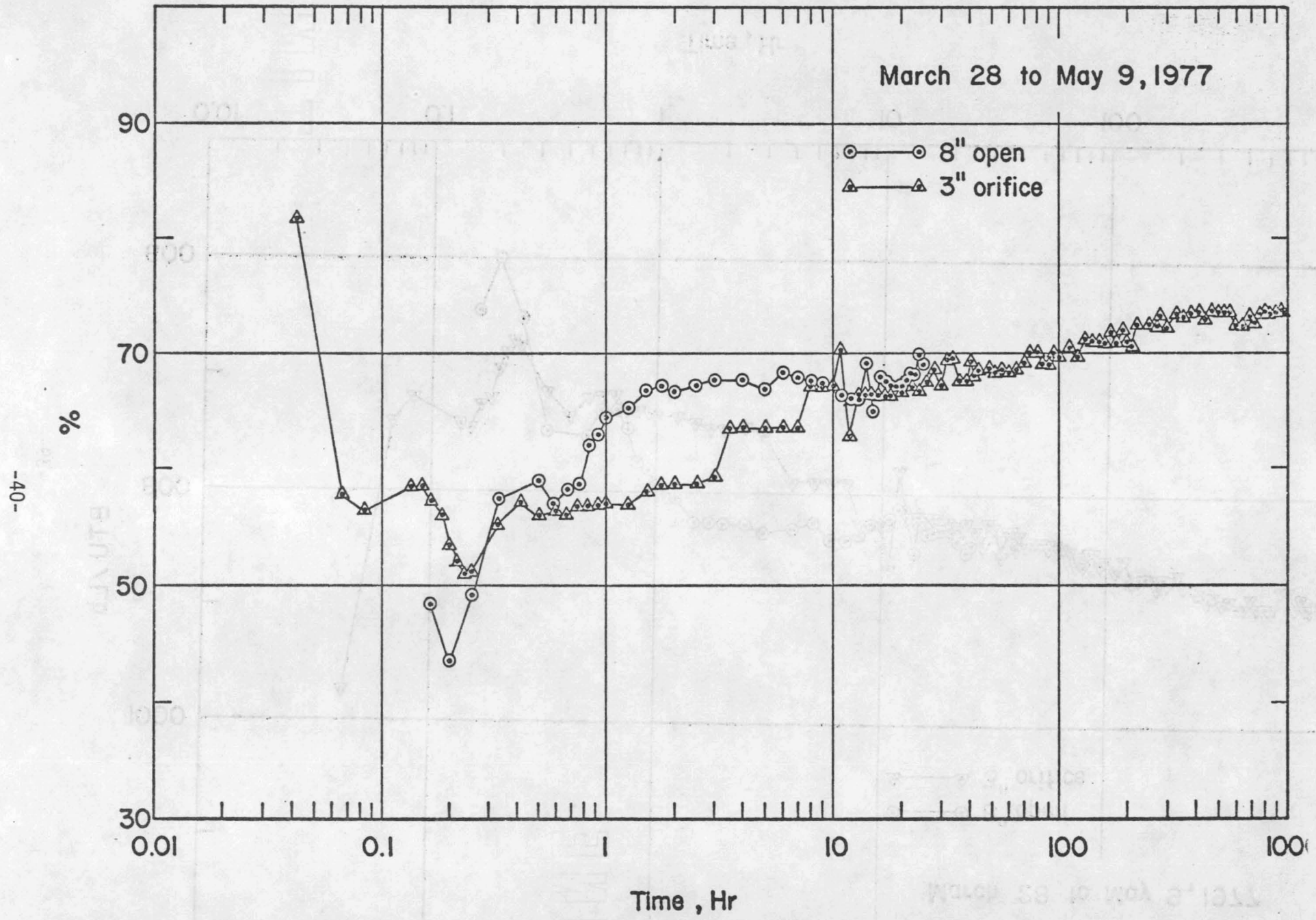

Figure 30. Steam Quality during March-May Flow Test

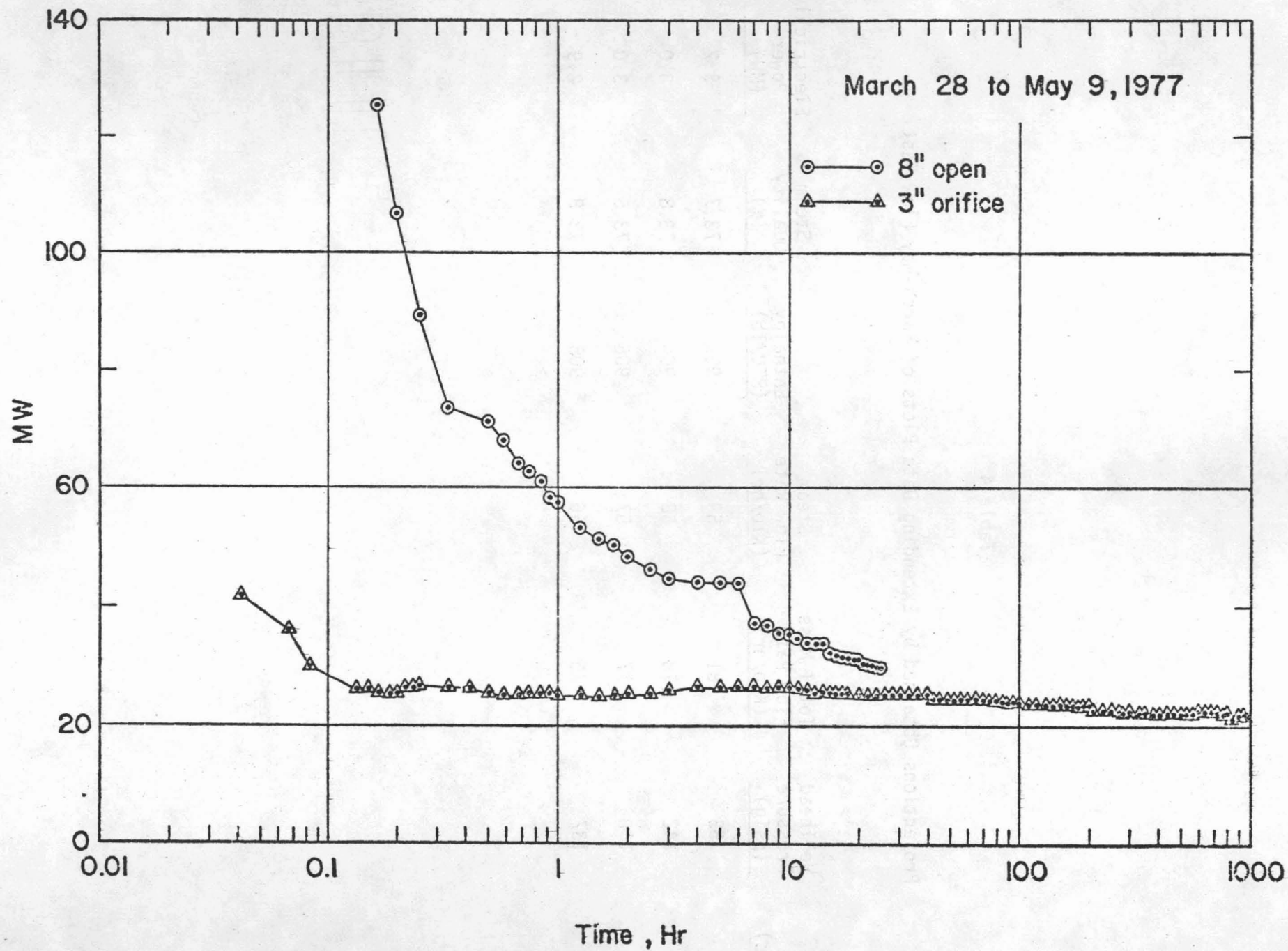

Figure 31. Thermal Power Output during March-May Flow Test

Table 4

Projections Obtained by Extending Data Plots of March-May Flow Test

<u>Time (Years)</u>	<u>Wellhead Pressure (psig)</u>	<u>Total Mass Flow Rate (Klb/hr)</u>	<u>Steam Flow Rate (Klb/hr)</u>	<u>Enthalpy (BTU/lb)</u>	<u>Steam Quality (%)</u>	<u>Electrical Power (MW)</u>
1	153	81	59	900	73.7	3.2
15	142	78	58	904	73.8	3.0
30	140	77	57	906	73.8	3.0
100	137	76	56	908	73.8	2.9

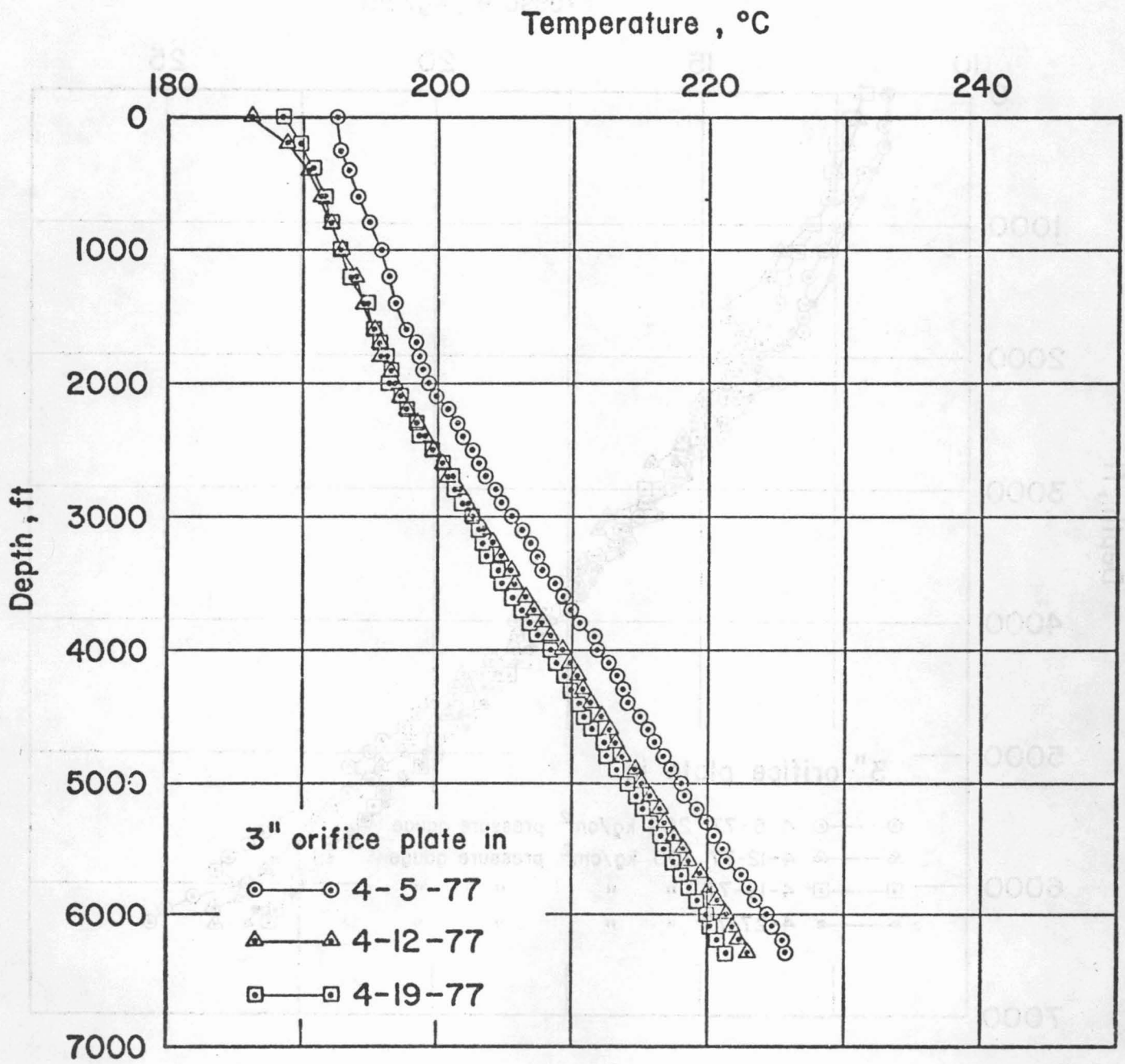

Figure 32. Temperature Profiles during March-May Flow Test

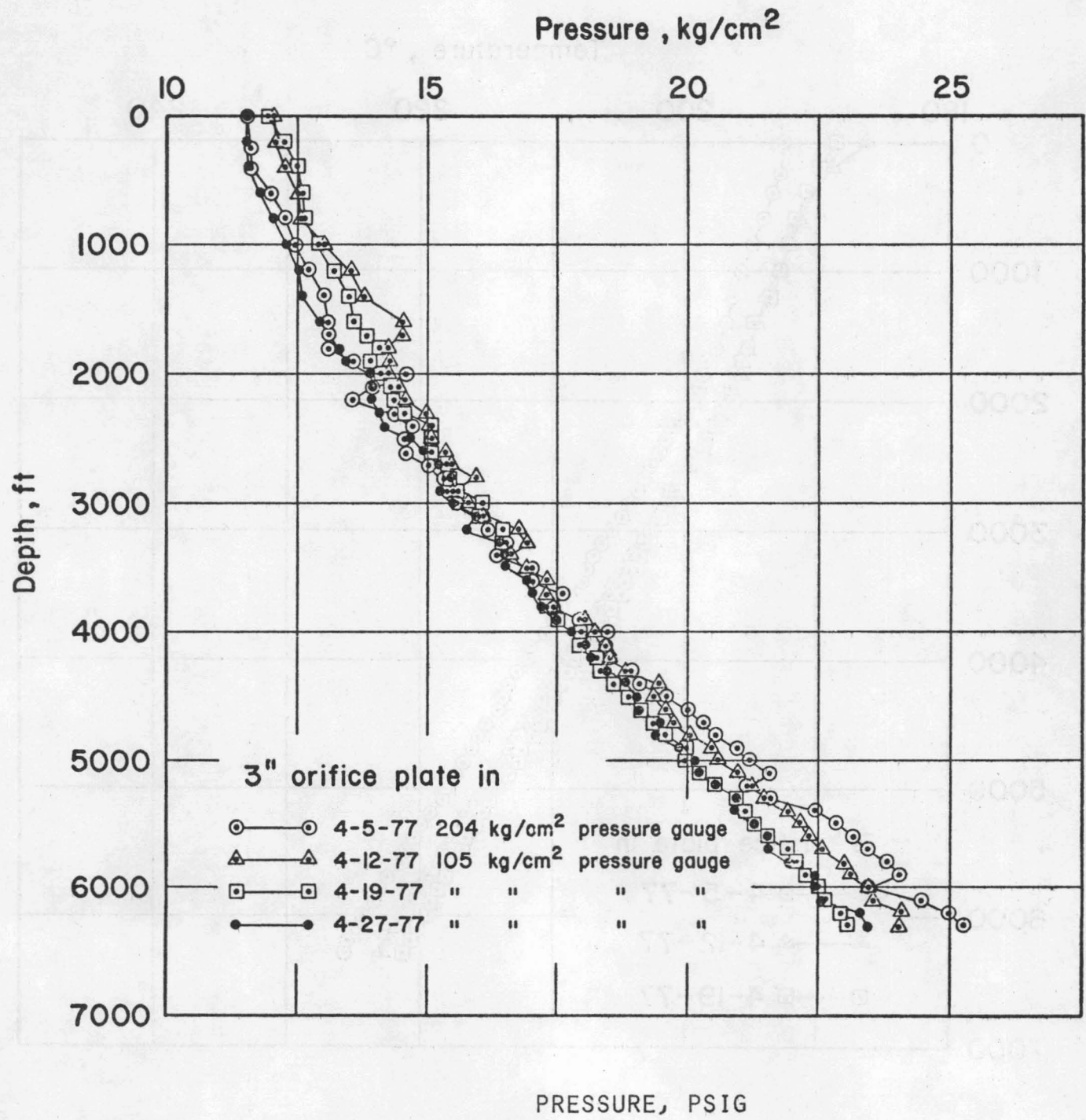

Figure 33. Pressure Profiles during March-May Flow Test.

TABLE 5

COMPARISON OF DISCHARGE TESTS AT 25 HOURS AFTER INITIATION OF FLOW

	<u>NOVEMBER</u>	<u>DECEMBER</u>	<u>JANUARY</u>	<u>MARCH</u>
WELLHEAD PRESSURE (PSIG)	47	53	59	59
WELLHEAD TEMPERATURE (°C)	146	150	151	153
LIP PRESSURE (PSIG)	7.9	10.1	12.5	13.9
WEIR HEIGHT (INCHES)	3-1/2	4	4-1/8	4-3/16
WEIR TEMPERATURE (°F)	203	205	205	203
MASS FLOW RATE (KLB/HR)	87.9	103.4	114.3	120.4
LIQUID FLOW RATE (KLB/HR)	27.9	39.5	42.5	45.2
STEAM FLOW RATE (KLB/HR)	60.0	63.9	71.8	75.2
STEAM QUALITY (%)	68	62	63	62
ENTHALPY (BTU/LB)	888	833	845	842
THERMAL POWER (MW)	22.9	25.2	28.3	29.7

PRESSURE DRAWDOWN AND BUILDUP ANALYSES

While data sufficient to assess a producible geothermal field can be obtained only from a number of properly-spaced wells, some limited reservoir information can be obtained from a single geothermal well by utilizing the theory developed for oil and gas fields. However, caution is needed in using these results because of several reasons, including the fact that the theory is basically one for single-phase flow and HGP-A produces two-phase flow. A summary of the basic theory and references is given in HGP Engineering Technical Memorandum No. 2, Geothermal Reservoir and Well Test Analysis: A Literature Survey, 1974, by B. H. Chen.

During the two-week flash discharge test in November, pressure drawdown test data were collected, and after the one-week test in December and the two-week test in January-February, pressure buildup test data were collected by dropping pressure probes to bottomhole. Results from the analyses of these three tests are given below.

1. Pressure Drawdown Analysis

Wellhead pressure vs. time plotted on log-log scales for type-curve matching and on semi-log scales for a pressure drawdown analysis are shown in Figures 34 and 35 respectively. The initial pressure was obtained from Figure 36. While these data can be used in a pressure drawdown analysis to obtain information about the geothermal reservoir, some skepticism must be directed towards this analysis because of the following reasons:

- a. The analysis is based on a constant production rate during the discharge, and this condition was not met during the November test. In order to apply the theory, a normalized pressure was obtained by dividing the measured pressure by the concomitant production rate.

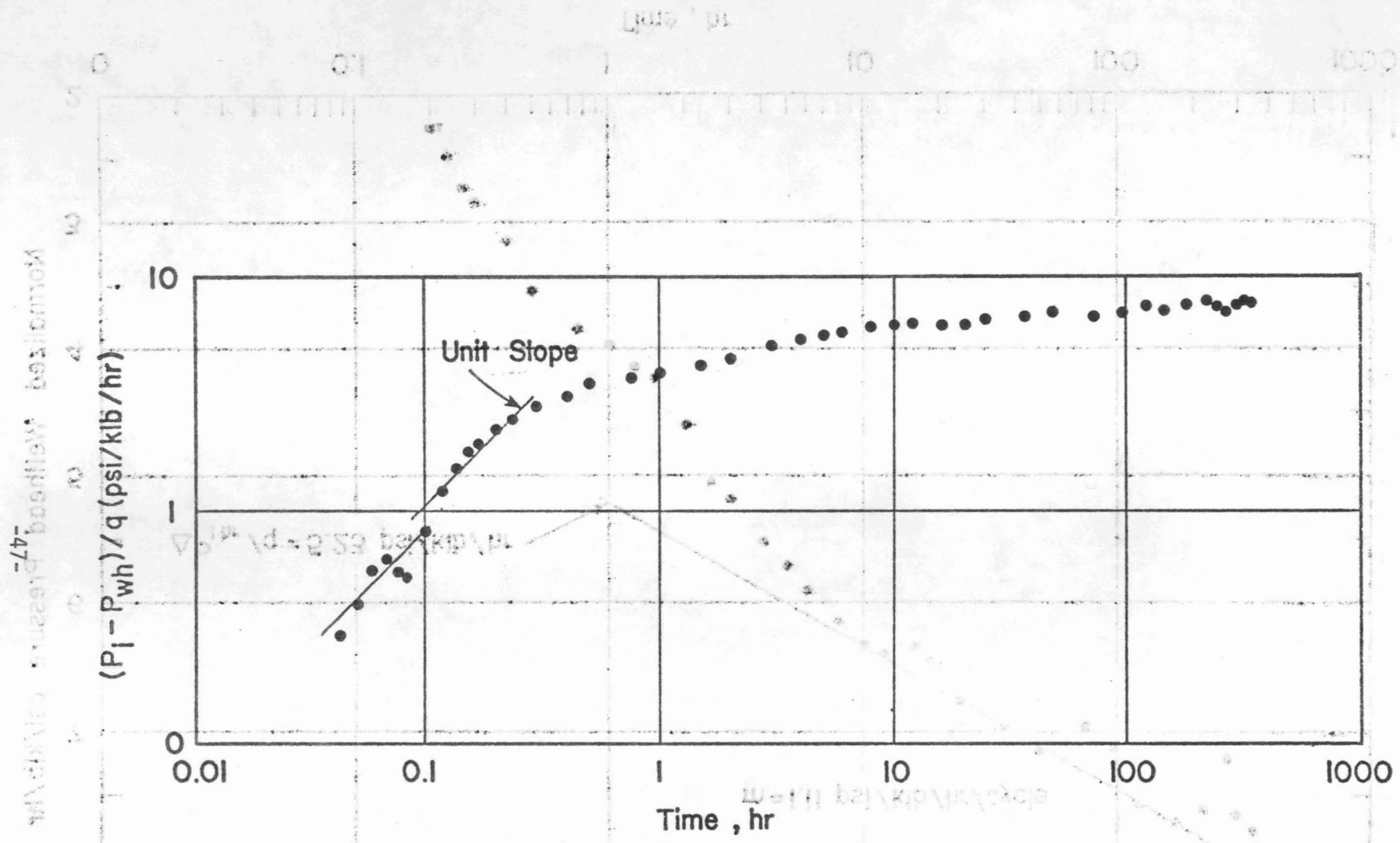

Figure 34. Log-Log Plot of November Discharge Test Data

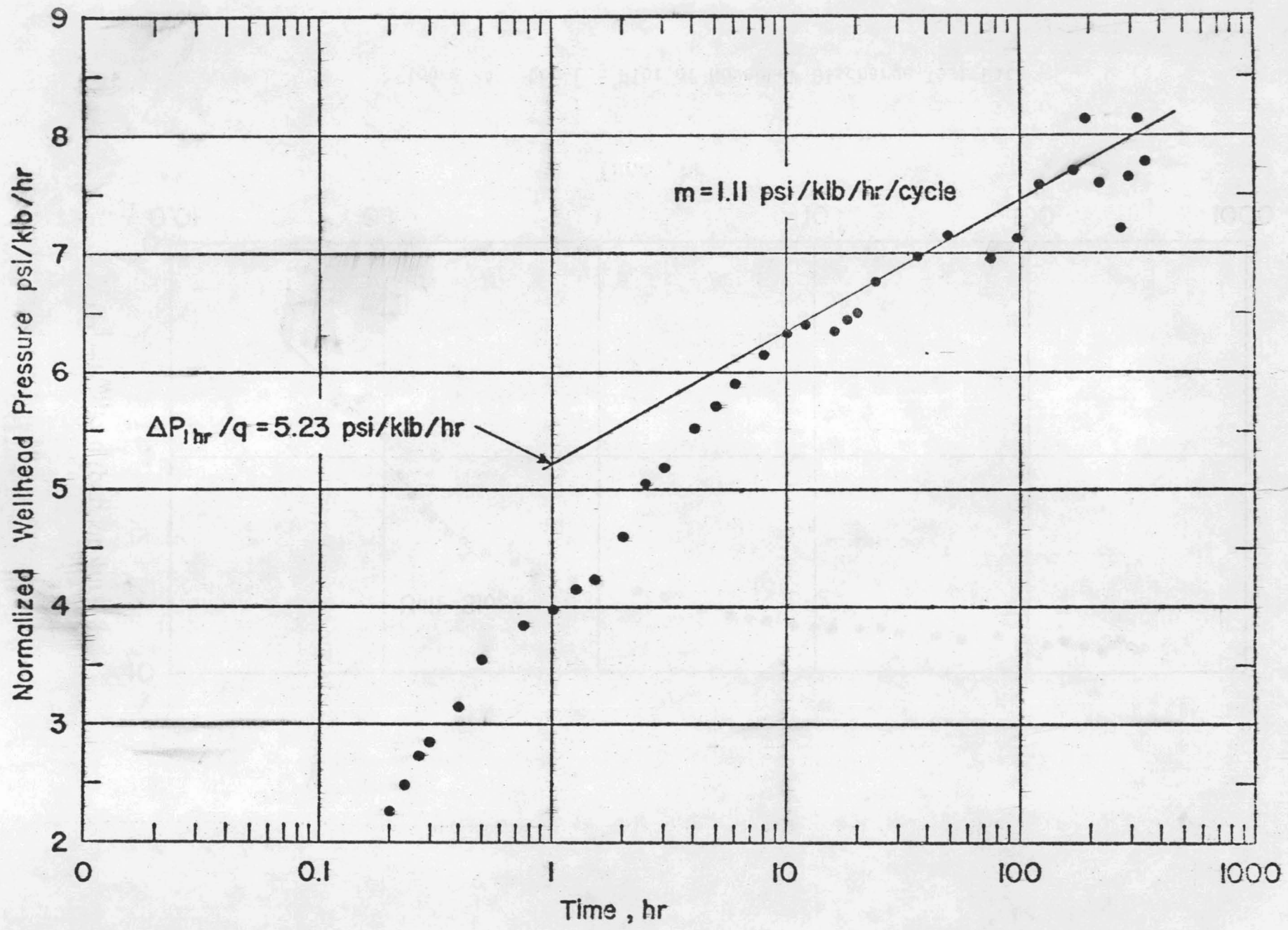

Figure 35 Semi-Log Plot of November Discharge Test Data

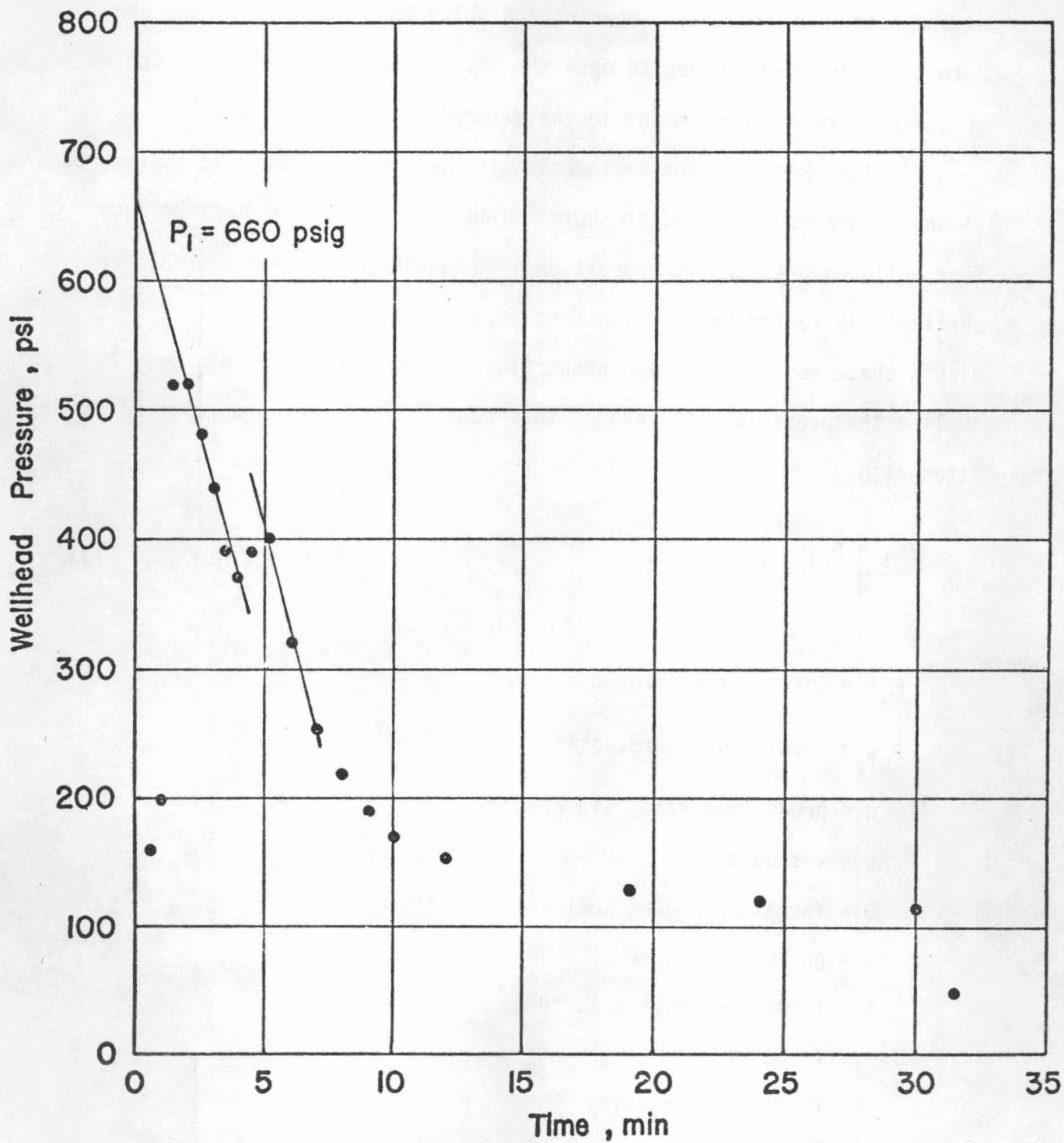

Figure 36. Linear Plot of Initial Data for November Discharge Test

b. There was some overpressure at the wellhead prior to the start of the test. Consequently, opening the valve took some effort and about 2 to 3 minutes were needed to open the valve completely. Thus, there is an uncertainty of that amount in the determination of zero time.

c. The theory is for bottomhole pressure whereas the data in Figures 34 and 35 are for wellhead pressure. Thus, the assumption must be made that wellhead pressure is proportional to downhole pressure and the proportionality factor remains constant throughout the test.

Within these restrictions and assumptions, some information can be obtained. To normalize the pressure with respect to production the pressure relation can be written as:

$$\frac{P_i - p_{wf}}{q} = \frac{162.6\mu B}{kh} \left(\log_{10} t + \log_{10} \frac{k}{\phi\mu C_t r_w^2} - 3.23 + 0.87s \right) \quad (1)$$

where

P_i = initial pressure, psi

p_{wf} = flowing pressure, psi

q = production rate, std bbl/day

μ = viscosity, cp

B = formation volume factor, res vol/std vol

k = permeability, md

h = formation thickness, feet

t = time, hr

ϕ = fractional porosity

C_t = total system effective isothermal compressibility, psi^{-1}

r_w = well radius, ft

s = skin effect factor

The left side of equation (1) is a linear function of $\log_{10} t$ so that a plot of $\frac{P_i - P_{wf}}{q}$ vs. $\log_{10} t$ will yield a straight line with a slope, m , psi/bbl/day/cycle, where

$$|m| = \frac{162.6\mu B}{kh} \quad (2)$$

and this equation can be used to calculate the permeability-thickness, kh .

Equation (1) can also be used to calculate the skin effect factor, s . Letting p_{1hr} be the value of p_{wf} for $t=1$ hour on the correct semi-log straight line, equation (1) can be rearranged to yield:

$$s = 1.15 \left(\frac{\frac{P_i - P_{1hr}}{q}}{|m|} - \log_{10} \frac{k}{\phi\mu C_t r_w^2} + 3.23 \right) \quad (3)$$

By using (3), the pressure drop due to the skin effect can be calculated from:

$$\frac{\Delta p_s}{q} = 0.87 |m|s \quad (4)$$

and the flow efficiency:

$$FE = \frac{\frac{P_i - P_{wf} - \Delta p_s}{q}}{\frac{P_i - P_{wf}}{q}} \quad (5)$$

With the assumptions made previously, a log-log type-curve plot of $\frac{P_i - P_{wf}}{q}$ vs. t for the November test is shown in Figure 34. The two unit-slope lines shown verify the existence of wellbore storage effects. From the end of the second straight line, it appears that the semi-log straight line or the radial flow period started at about 10 hours after the test was begun.

Figure 35 is a semi-log graph of $\frac{P_i - P_{wf}}{q}$ vs. $\log_{10} t$. An analysis of the plotted data shows that the permeability thickness:

$$kh = \frac{(162.6) (24 \text{ hr/day}) (0.09 \text{ cp}) (1.5 \text{ res bbl/std bbl})}{(350 \text{ lb/bbl}) (1.11 \times 10^{-3} \text{ psi/lb/hr/cycle})}$$

$$kh = 1356 \text{ md-ft}$$

and if the thickness of the producing layer is assumed to be $h = 1000 \text{ ft.}$, then the permeability:

$$k = 1.4 \text{ md.}$$

The skin effect factor:

$$s = 1.15 \left[\frac{5.23 \times 10^{-3}}{1.11 \times 10^{-3}} - \log_{10} \frac{1.4}{(0.03)(0.09)(8 \times 10^{-6}) \left(\frac{8.755}{24}\right)^2} + 3.23 \right] = -0.86$$

The small negative skin effect factor suggests that skin damage is not present. Therefore, the flow efficiency of the well is approximately 1, or the well is discharging as much as it is able to produce,

The minimum drainage area for the duration of the November flow test can be estimated to be:

$$A = \frac{0.000264 (1.4)(3.36)}{(0.03)(0.09)(8 \times 10^{-6})(0.05)} = 1.15 \times 10^8 \text{ ft}^2$$

Thus, the minimum volume reached during this discharge test was:

$$Ah = 0.8 \text{ cu mile.}$$

2. December Pressure Buildup Analysis

As with the pressure drawdown test, the pressure buildup test employs the standard methods used in petroleum and gas field analysis. The end of the December discharge test permitted a pressure buildup test. Bottom-hole pressures were taken by two Kuster KPG pressure elements and recorders in tandem to ensure that pressure data were acquired since considerable difficulty had been experienced with equipment malfunction because of the very high temperature.

Figure 37 is a log-log type-curve plot of $(P_{ws} - P_{wf})$ vs. t . It shows two distinct wellbore storage effects as in the pressure drawdown test; the top of the second wellbore storage effect is indicated by the Arrow A. The rule of thumb used is that the onset of the radial flow period on the conventional semi-log straight line is $1\frac{1}{2}$ log cycle beyond A, which is indicated by the arrow B. This time is approximately 70 hours after well shut-in.

Figure 38 is a semi-log graph of $(P_{ws} - P_{wf})$ vs. $\log_{10} \frac{t + \Delta t}{\Delta t}$.

From the curves the permeability-thickness:

$$kh = \frac{162.6 (87.700)(24)(0.09)(1.5)}{(350)(150)} = 880 \text{ md-ft}$$

Again, if the height of the producing layer is assumed to be $h = 1000$ ft, then $k = 0.88$ md-ft.

The skin effect factor:

$$s = 1.15 \left[\frac{1900 - 467}{130} - \log_{10} \frac{.88}{(0.03)(0.09)(8 \times 10^{-6}) \left(\frac{8.755}{24} \right)^2} + 3.23 \right]$$

$$= 4.30$$

The pressure drop across the skin:

$$\Delta p_s = (0.87)(150)(4.30) = 561 \text{ psi}$$

and the flow efficiency:

$$FE = \frac{2300 - 467 - 561}{2300 - 467} = 0.65$$

This result indicates the well is producing about 65% of the capability without damage.

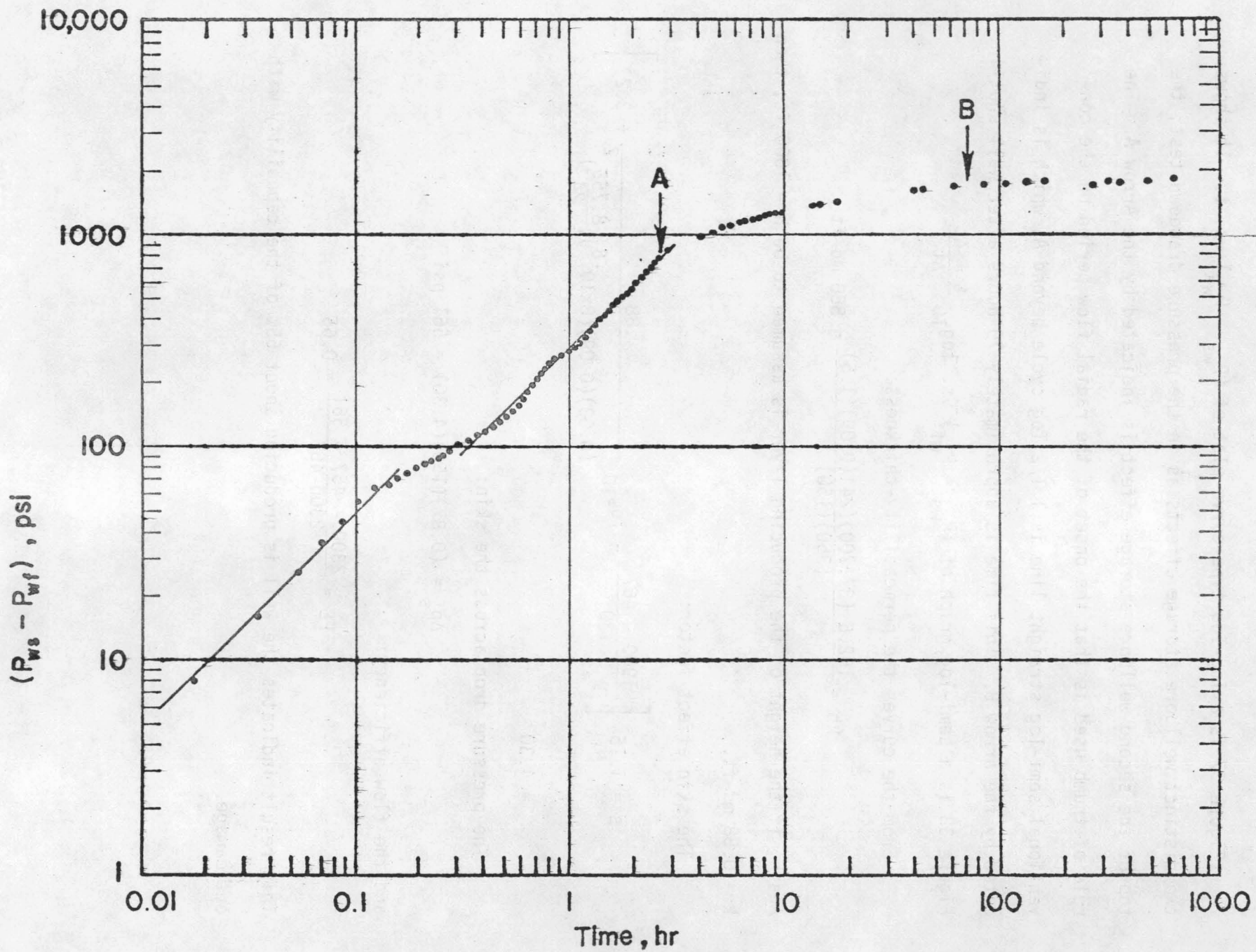

Figure 37. Log-Log Plot of December Pressure Buildup Test Data

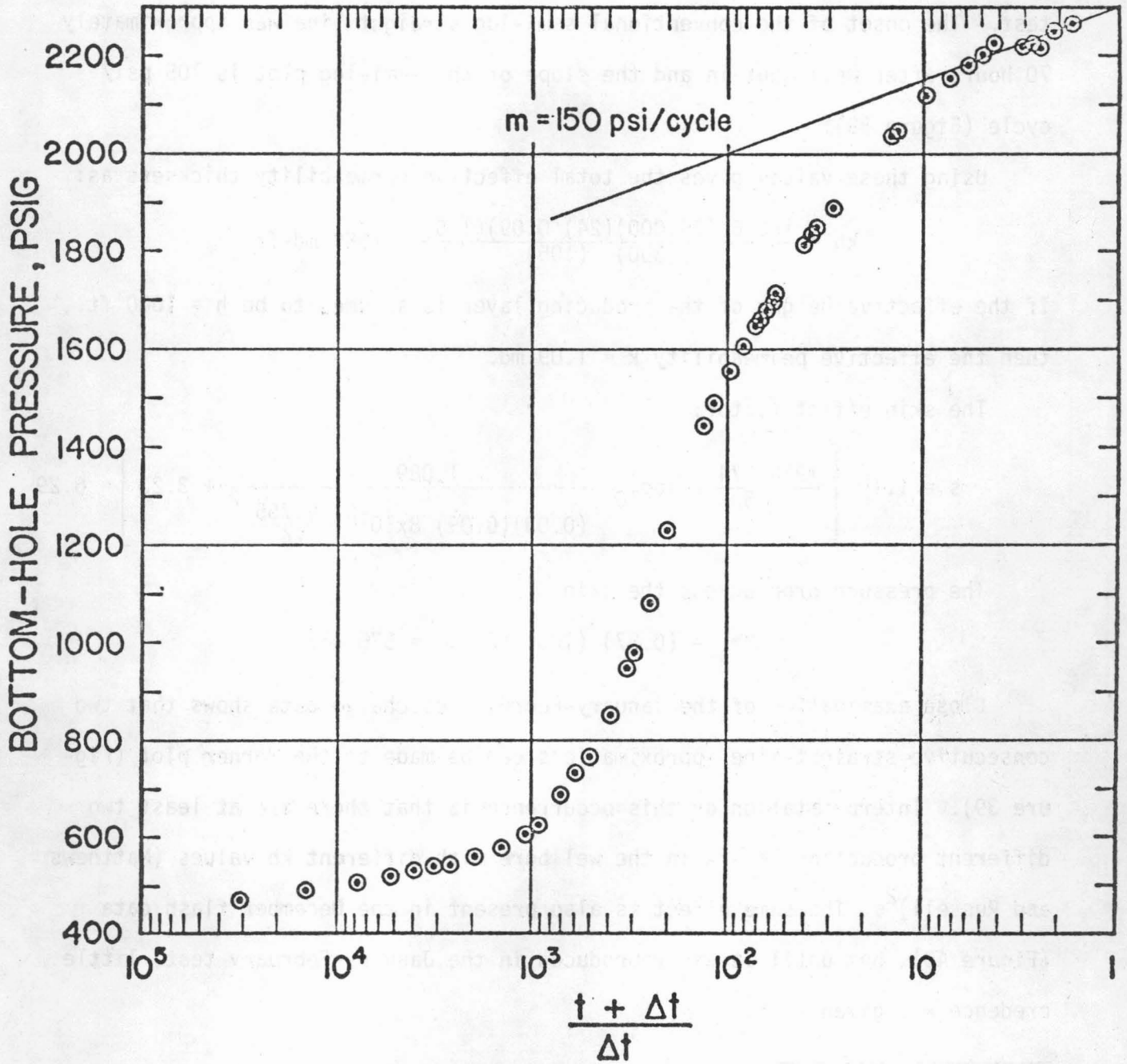

Figure 38. Semi-Log Plot of December Pressure Buildup Test Data

3. January-February Pressure Buildup Analyses

Bottomhole pressure measurements made after HGP-A was shut-in on February 11, 1977 produced data and plots similar to that obtained for the December test. The onset of the conventional semi-log straight line was approximately 70 hours after well shut-in and the slope of the semi-log plot is 105 psi/cycle (Figure 39).

Using these values gives the total effective permeability thickness as:

$$kh = \frac{162.6 (76,000)(24)(0.09)(1.5)}{(350) \cdot (105)} = 1089 \text{ md-ft}$$

If the effective height of the producing layer is assumed to be $h = 1000 \text{ ft.}$, then the effective permeability $k = 1.09 \text{ md.}$

The skin effect factor:

$$s = 1.15 \left[\frac{1910-774}{105} - \log_{10} \frac{1.089}{(0.03)(0.09) 8 \times 10^{-6} \frac{8.755}{24}^2} + 3.23 \right] = 6.29$$

The pressure drop across the skin:

$$\Delta p_s = (0.87) (105) (6.29) = 575 \text{ psi}$$

Close examination of the January-February discharge data shows that two consecutive straight-line approximations can be made to the Horner plot (Figure 39). Interpretation of this occurrence is that there are at least two different production layers in the wellbore with different kh values (Matthews and Russell)². The same effect is also present in the December flash data (Figure 40), but until it was reproduced in the January-February test, little credence was given to it.

² C.S. Matthews and D.G. Russell, Pressure Buildup and Flow Tests in Wells, SPE Monograph Volume 1 (1967).

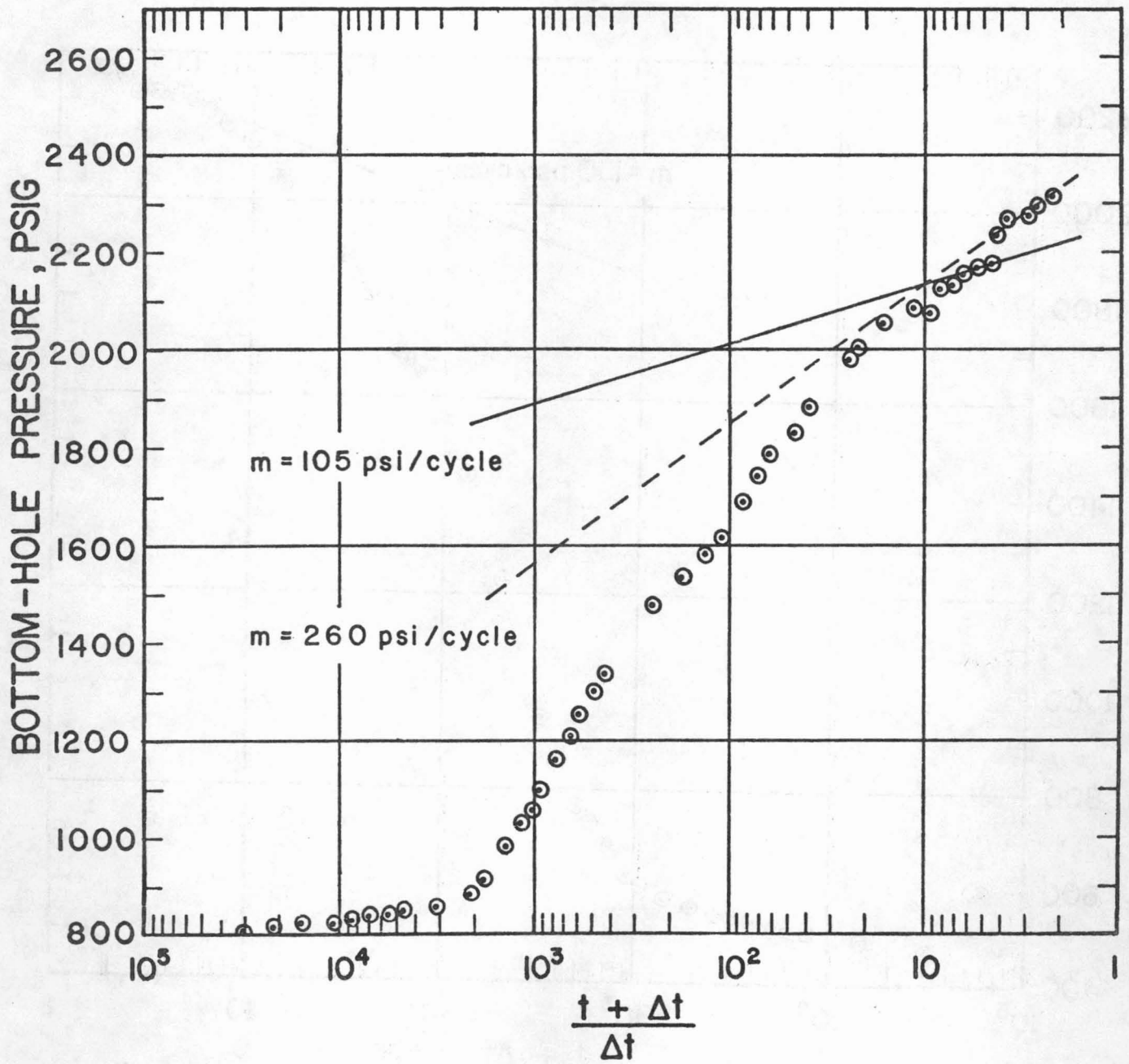

Figure 39

SEMI-LOG PLOT OF JANUARY PRESSURE BUILDUP TEST DATA

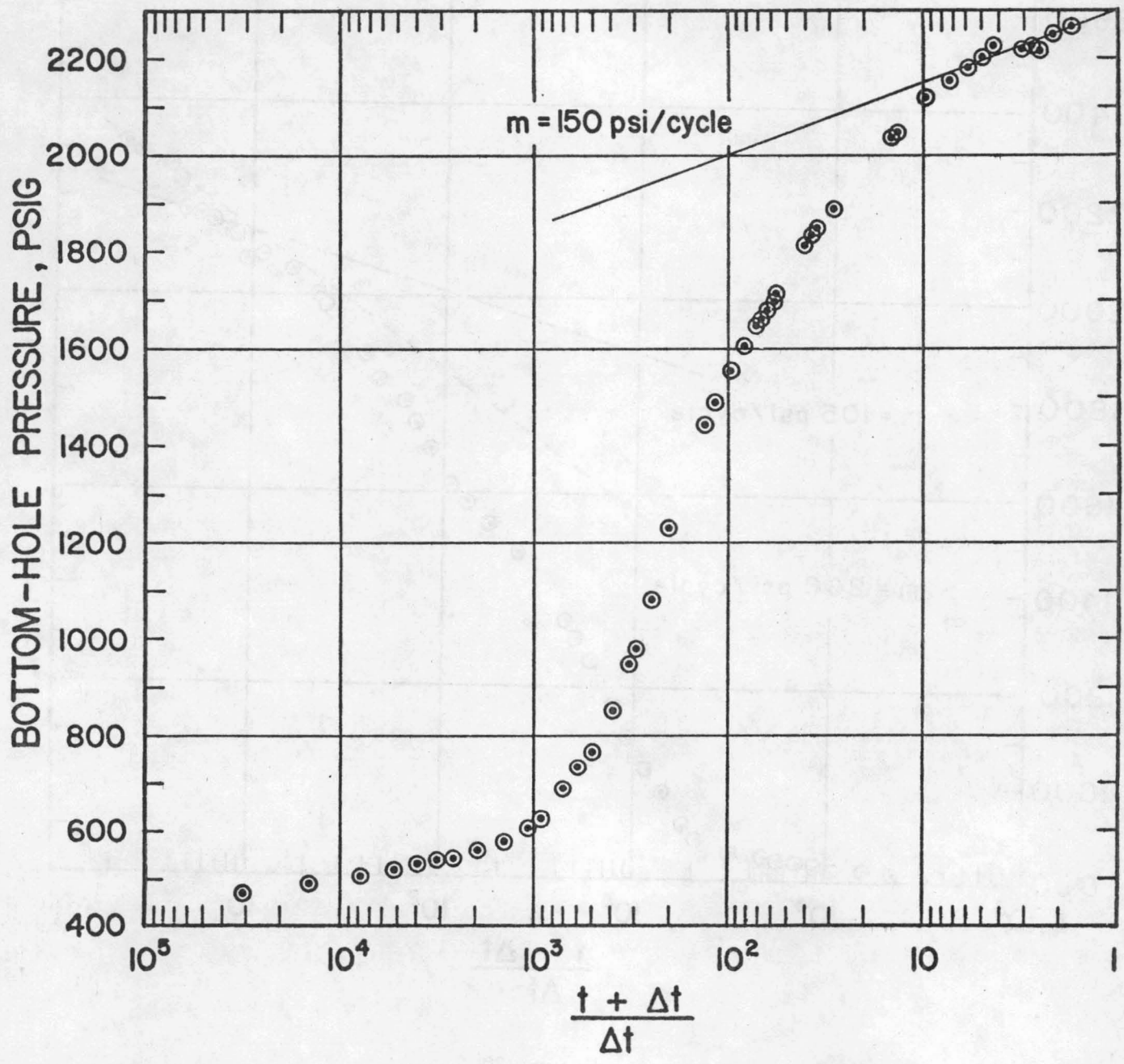

Figure 40

SEMI-LOG PLOT OF DECEMBER PRESSURE BUILDUP TEST DATA

Since the reservoir has at least two producing layers, the traditional Matthews-Bros-Hazebroek method of extrapolating formation average pressure cannot be used and the Miller-Dyes-Hutchinson method (Miller, Dyes and Hutchinson;³ Perrine;⁴ Matthews and Russell²) must be used to obtain the value of the formation average pressure. The value is:

$\bar{p} = 2174$ psi with no influx of fluid over the drainage boundary
 or $\bar{p} = 2214$ psi with constant pressure at the drainage radius.

With the above pressures, the flow efficiency values are:

$FE = \frac{2174 - 774 - 575}{2174 - 774} = 0.59$ with no influx of fluid over the drainage boundary
 or $FE = \frac{2214 - 774 - 575}{2214 - 774} = 0.60$ with constant pressure at the drainage radius.

4. Recalculation of December Data

If the analysis of the December Horner plots is redone to account for two producing layers, the permeability thickness:

$$kh = \frac{162.6 (87,700) (24) (0.09) (1.5)}{(350) (85)} = 1553 \text{ md-ft.}$$

And if the effective thickness of the producing layer is assumed to be $h = 1000$ ft., then the effective permeability $k = 1.55$ md.

The skin effect factor:

$$s = 1.15 \left[\frac{2032-467}{85} - \log_{10} \frac{1.553}{(0.03)(0.09)(8 \times 10^{-6}) \left(\frac{8.755}{24}\right)^2} + 3.23 \right] = 14.8$$

The pressure drop across the skin:

$$\Delta p_s = (0.87) (85) (14.8) = 1098 \text{ psi.}$$

² Ibid.

³ C.S. Miller, A.B. Dyes and C.A. Hutchinson, Jr., The Estimation of Permeability and Reservoir Pressure from Bottomhole Pressure Build-up Characteristics, Trans., HIME (1950).

⁴ R.L. Perrine, Analysis of Pressure Buildup Curves, Drill. and Prod. Prac., API (1956).

Employing the Miller-Dyes-Hutchinson method for calculating the average formation pressure results in formation average pressure values of:

$$\bar{p} = 2206 \text{ psi with no influx of fluid over the drainage boundary}$$

or
$$\bar{p} = 2214 \text{ psi with constant pressure at the drainage radius.}$$

With these values, one can calculate the flow efficiency to be:

$$FE = \frac{2206 - 467 - 1098}{2206 - 467} = 0.37 \quad \text{with no influx of fluid over the drainage boundary}$$

or
$$FE = \frac{2238 - 467 - 1098}{2238 - 467} = 0.38 \quad \text{with constant pressure at the drainage radius.}$$

5. Discussion

Table 6 summarizes the preceding analyses of the pressure drawdown and buildup tests. The permeability-thickness figures from all analyses are similar, but the skin effects and flow efficiencies are different. The assumptions for a pressure drawdown analysis include the production of fluid at a constant rate, which is difficult to satisfy in practice. In order to apply the theory, the pressure data were normalized by dividing by the production rate, which can be questioned for its validity. On the other hand, the pressure buildup analysis has no similar, difficult assumption to satisfy in practice. Thus, more reliable conclusions can be drawn from the pressure buildup tests and analyses.

In a preliminary way the analyses of the pressure buildup tests indicate that the reservoir is tight (low permeability of perhaps less than 1 millidarcy) and that the well suffers from significant skin damage, resulting in a discharge rate of only 38-60% of what it is capable. This latter tentative conclusion is supported by the data in Table 5, which shows that the flow rates have increased with each test. This may have been a result of the initial surge in each test, which either removed the baked-in mud and thus reduced the skin damage, or possibly induced stress-caused microfractures.

TABLE 6

COMPARISON OF PRESSURE DRAWDOWN AND BUILDUP TESTS

	<u>CONSTANT PRODUCTION DRAWDOWN</u>	<u>DECEMBER BUILDUP TWO-LAYER</u>	<u>DECEMBER BUILDUP ONE-LAYER</u>	<u>JAN-FEB BUILDUP TWO-LAYER</u>
PERMEABILITY THICKNESS, KH, MD-FT.	1356	1553	880	1089
APPARENT SKIN FACTOR, S	- 0.86	14.8	4.3	6.3
PRESSURE DROP ACROSS SKIN, PSI	---	1098	561	575
FLOW EFFICIENCY	~ 1	0.38	0.65	0.60

It also appears that there are at least two production layers with different kh values. While the theory does not permit a calculation of the two kh values, its use indicates that the effective kh probably lies between 1000 and 1500 md-feet.

Reservoir Recovery Analysis

After each production test, the well was shut in. This quenched the well flow except for the four-hour test on July 22, 1976.

Figure 41 presents the water level recovery plots after each production flow test which resulted in quenching of the well flow. The first three flow test plots followed a common pattern and recovered in about thirty-five days, although the flow period varied from seven to fifteen days. The water recovery for the 42-day flow test, as shown, took almost twice as long to completely recover. When the plots are redrawn with a common point of zero depth, it is observed that below 200 feet each plot follows a similar slope (Figure 42). Table 7 presents a summary of the time flowed with respect to time recovered.

After each flow test was completed and the well shut in, temperature and pressure profiles were made of the wellbore. In each case, the temperature profiles followed similar patterns with respect to time (Figures 43 - 46).

These are: Depth, feet

0-1500	The temperature decreased sharply and rapidly. At approximately 1300 feet, a temperature inversion existed.
1500-2500	Sharp temperature increase.
2500-4000	Gradual temperature increase.
4000-4300	High temperature section.
4300-6200	Temperature inversion.
6200-6300	High temperature section.

11115

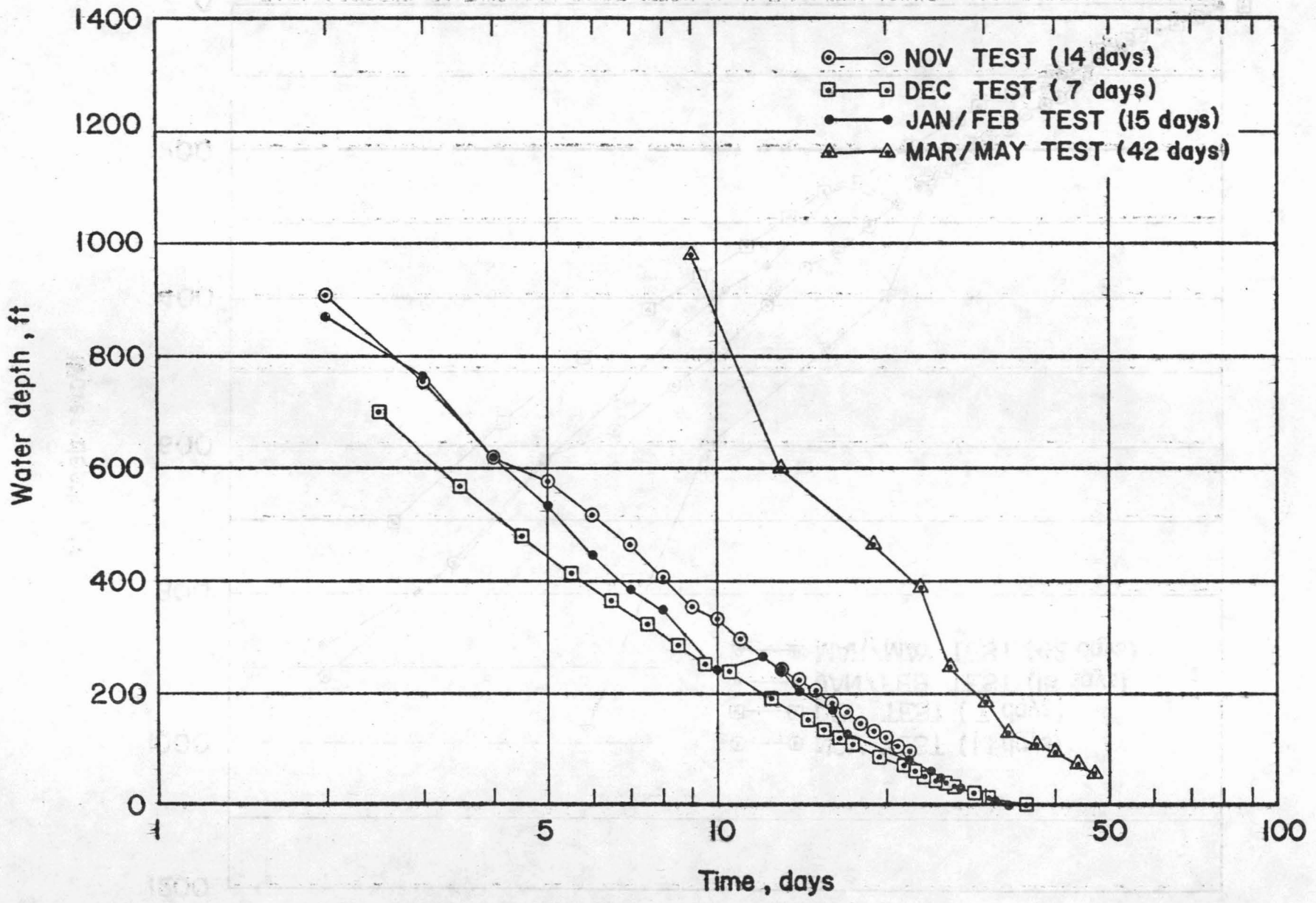

Figure 41. Water Level Recovery Rates

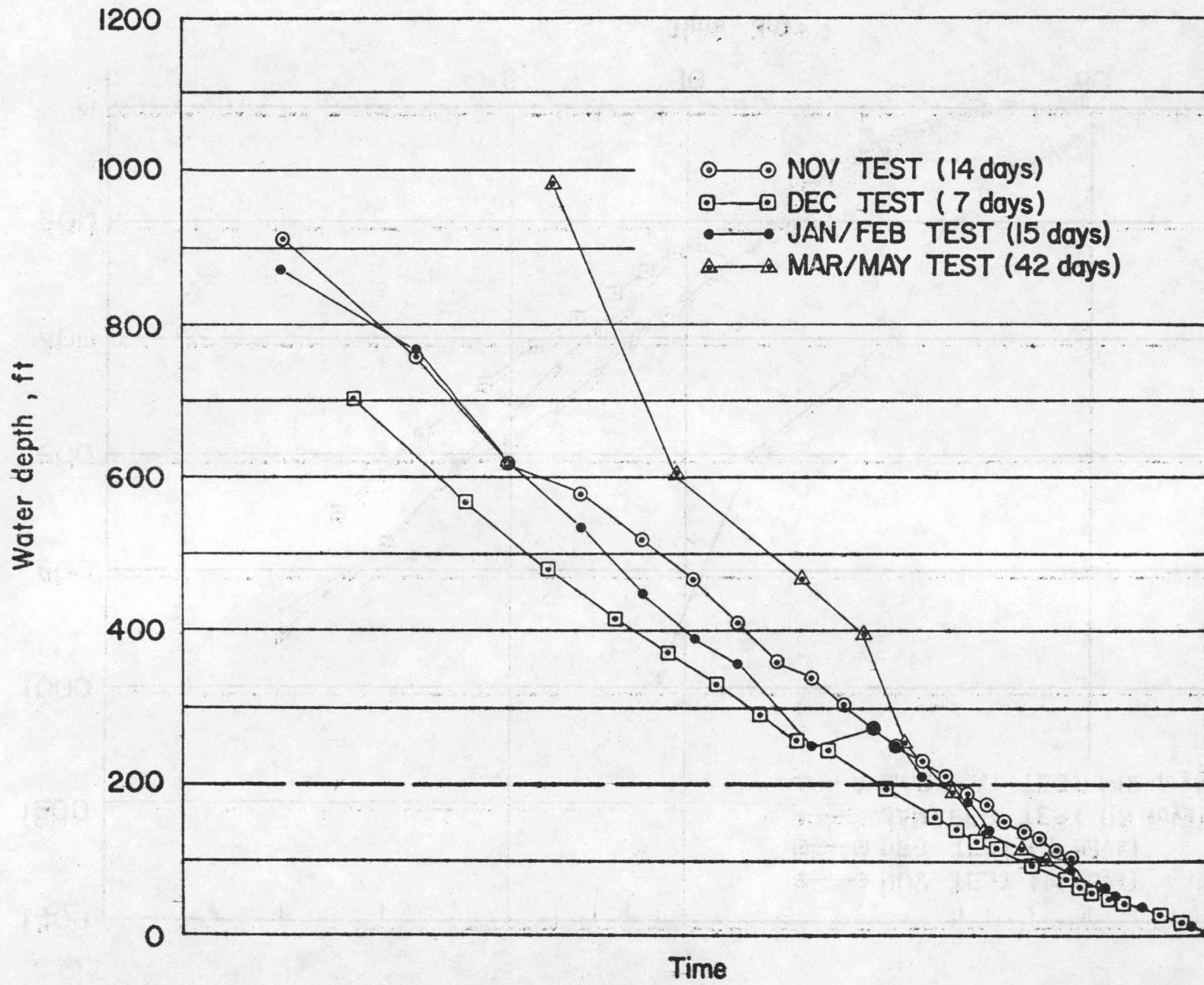

Figure 42. Water Level Recovery Rates (With Common Point of Zero Depth)

TABLE 7
SUMMARY OF WATER LEVEL RECOVERY

<u>Time Flowed</u> (days)	<u>Time Recovered</u> (days)
0.17 (4 hr)	0
7-15	35
42	65

TEMPERATURE, °C

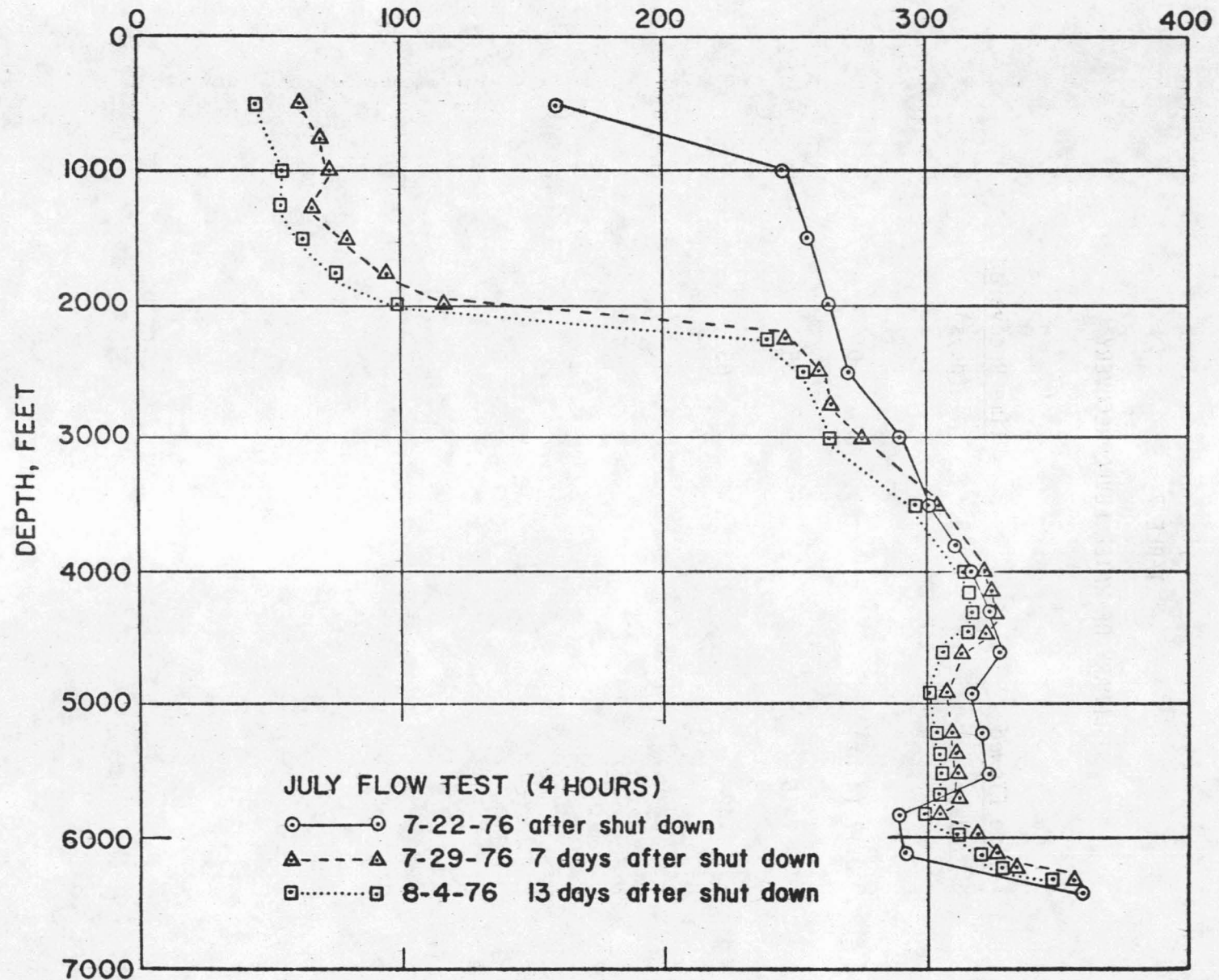

Figure 43. Temperature Recovery Following July Flow Test

TEMPERATURE, °C

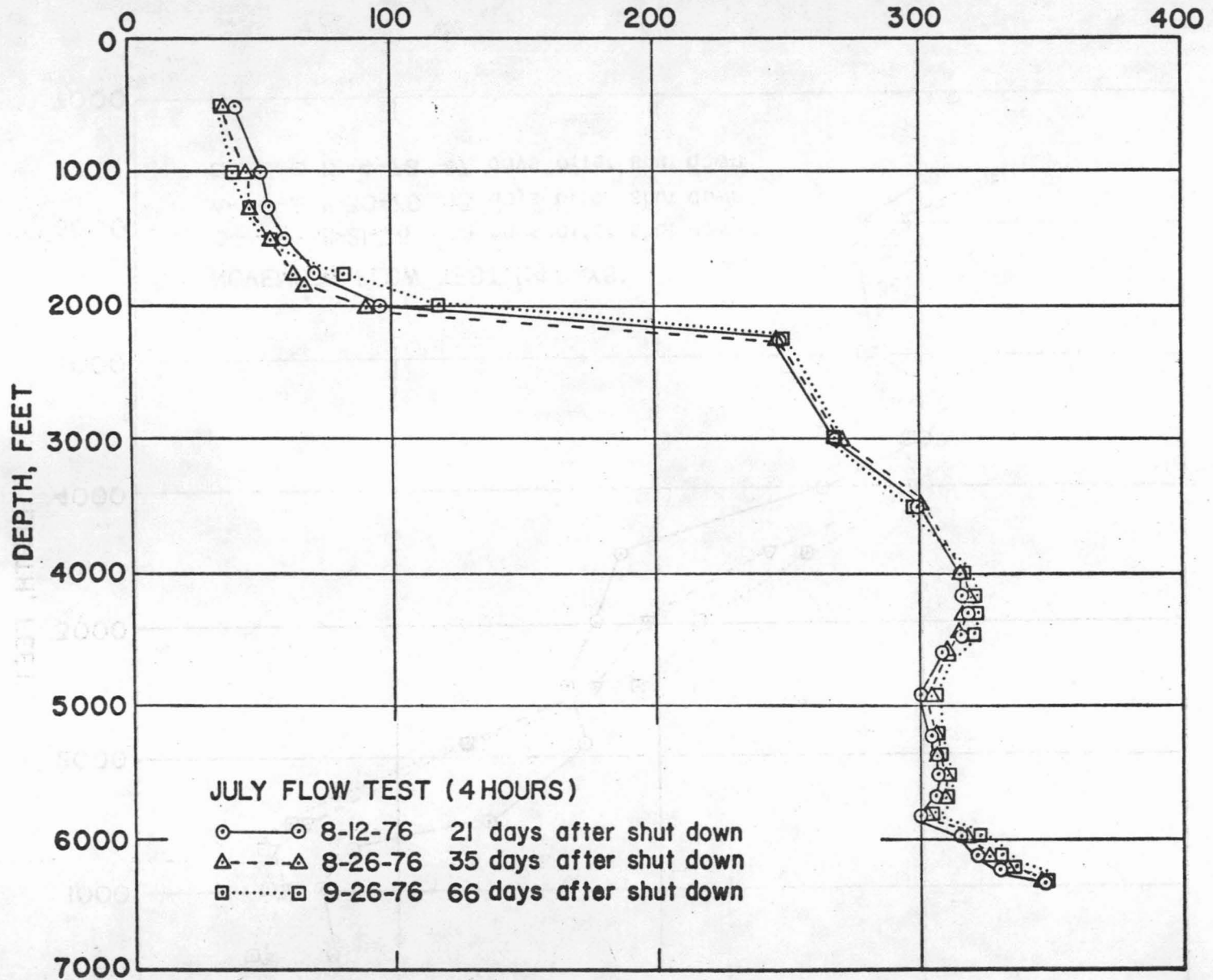

Figure 43. (cont.) Temperature Recovery Following July Flow Test

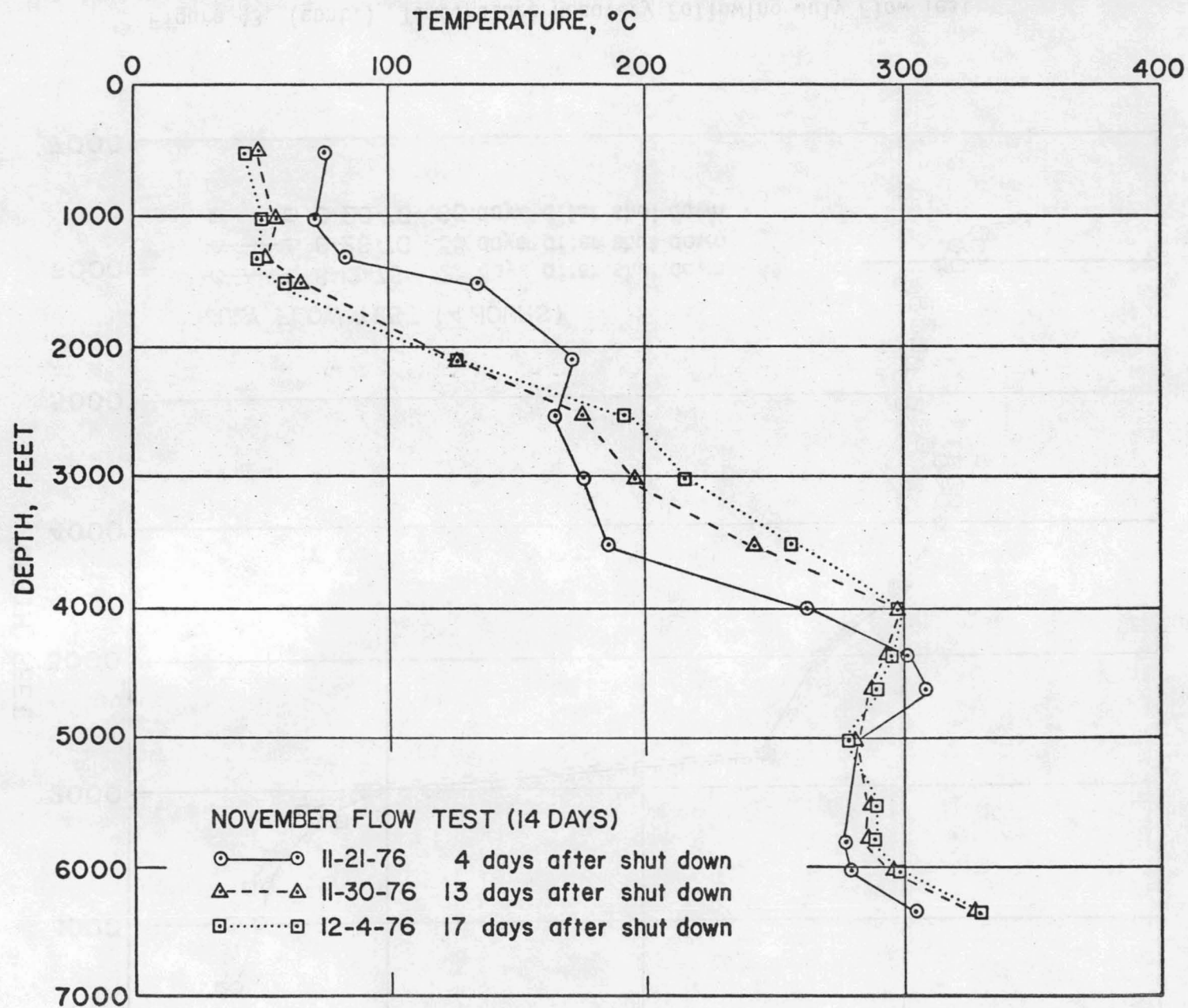

Figure 44. Temperature Recovery Following November Flow Test

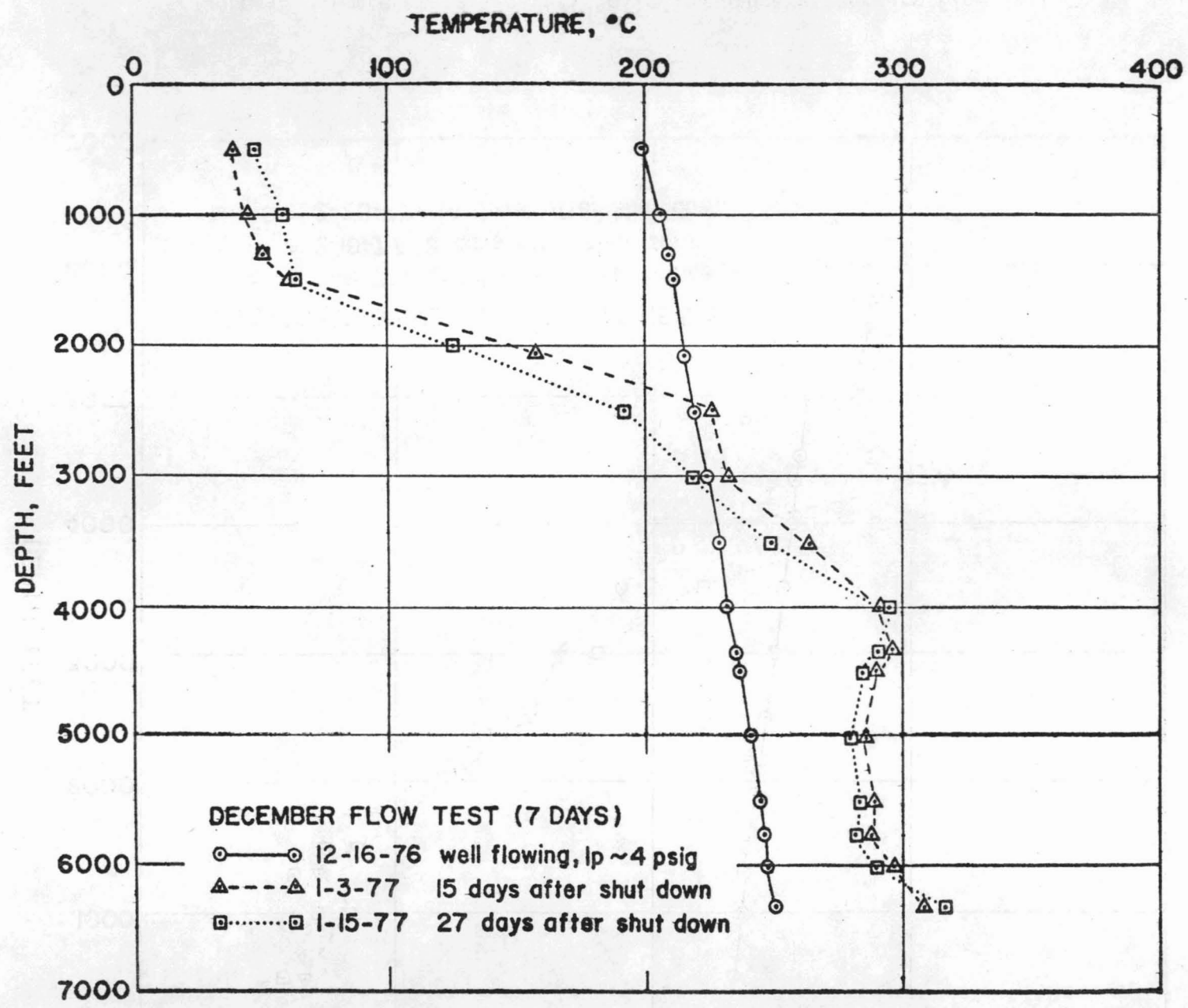

Figure 45. Temperature Recovery Following December Flow Test

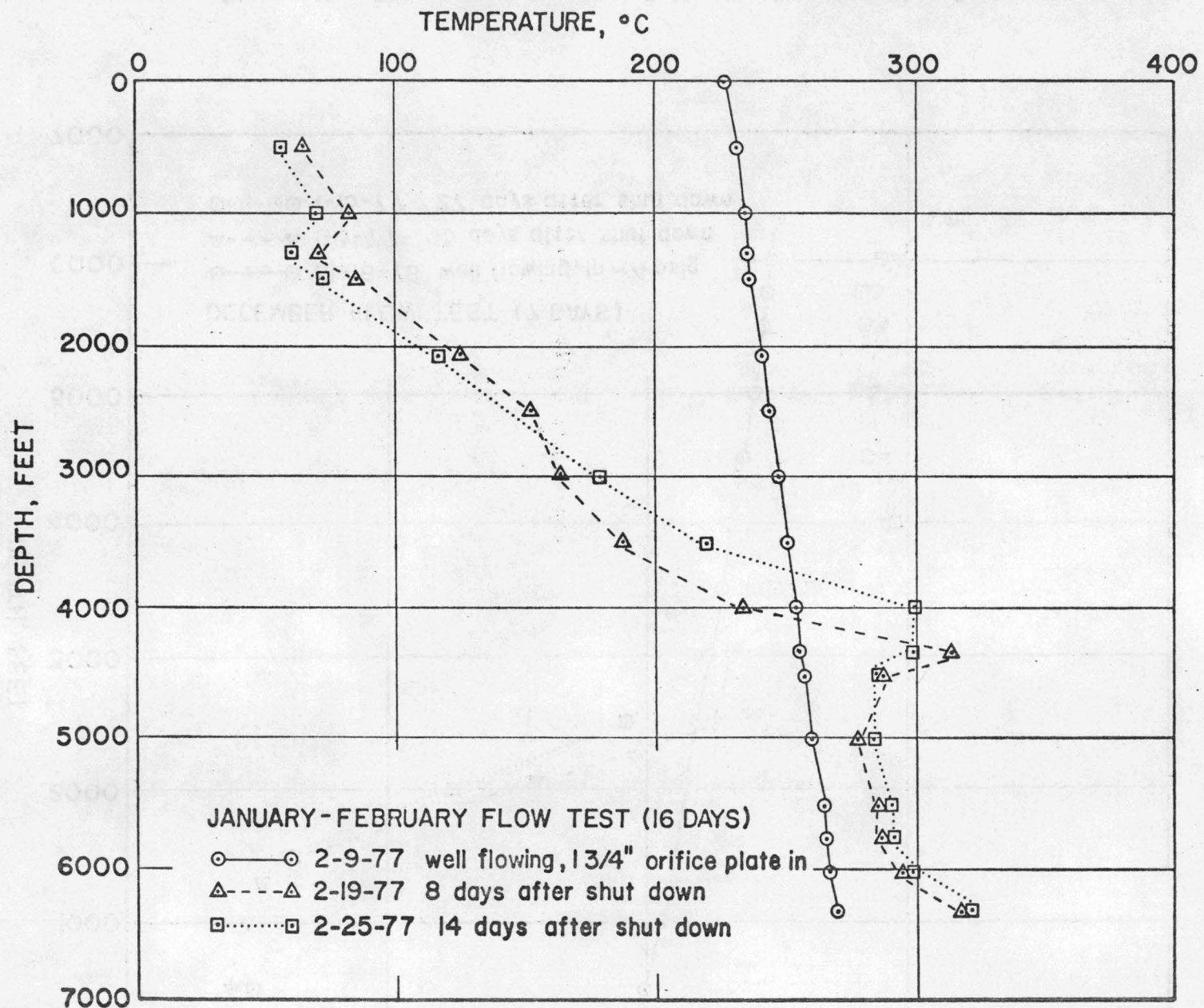

Figure 46. Temperature Recovery Following January/February Flow Test

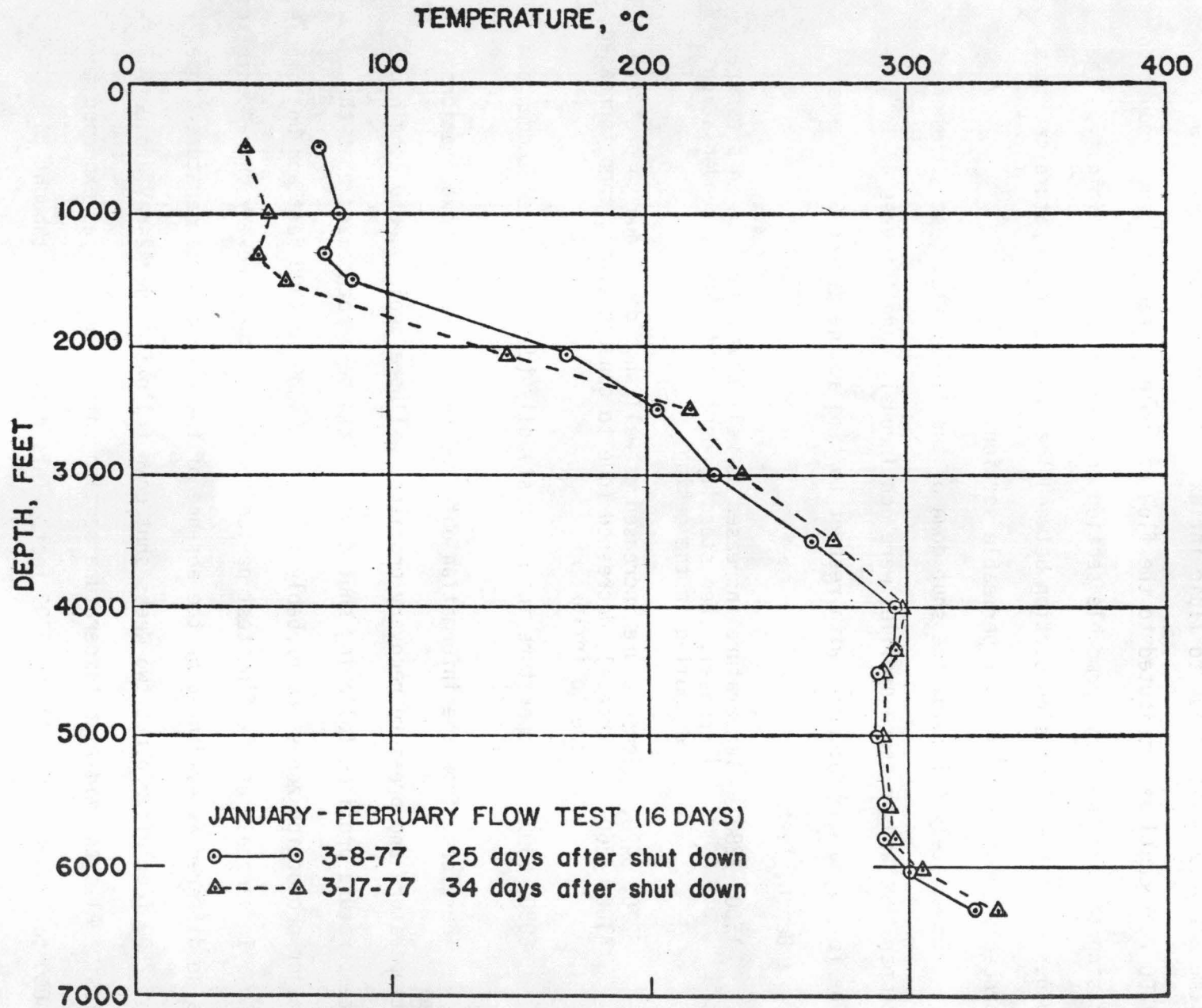

Figure 46. (cont.) Temperature Recovery Following January/February Flow Test

The high temperature sections occurring at similar depths indicate some activity possibly due to fluid influx. The temperature inversion at 1300 feet could be attributed to the flow of cooler water past the production casing through the very permeable section located in the near vicinity. The other and larger inversion section between the two high temperature sections probably constitutes a lower permeable section.

Immediately following the shut down of the 42-day flow test a number of temperature and pressure profiles were continuously made (Figures 47 to 50). The following were observed with respect to time at the depths of interest:

Depth, feet

1500, 2280	Temperature increased as well shut down (due to pressure increase), then steadily decreased (due to condensation and cooling in the casing).
3270, 3430, 4100, 4260	Temperature increased as well shut down (due to pressure increase), decreased (due to condensation), then increased (due to influx)
6080, 6300	Temperature increased steadily (due to well shut down and influx).

Therefore, from the information obtained through various examinations, temperature and pressure recovery profiles, wellbore geology, and continuous temperature profiles following shut down, it can be hypothesized that the major production zones are probably located at 4000 to 4300 feet and bottomhole.

In general, as the flow test period increased, the recovery characteristics also differed as evidenced by the absence of the change in temperature slope at 2500 feet after about two weeks shut down following the 42-day production test. Also the mid-high temperature section shifted as well as expanded from 4000 to 4300 feet to 4300 to 5000 feet. This difference is thought to be due to the expansion of the flash front into the reservoir and hence the longer recovery period. This was seen in the water level recovery which took almost twice as long to reach ground level.

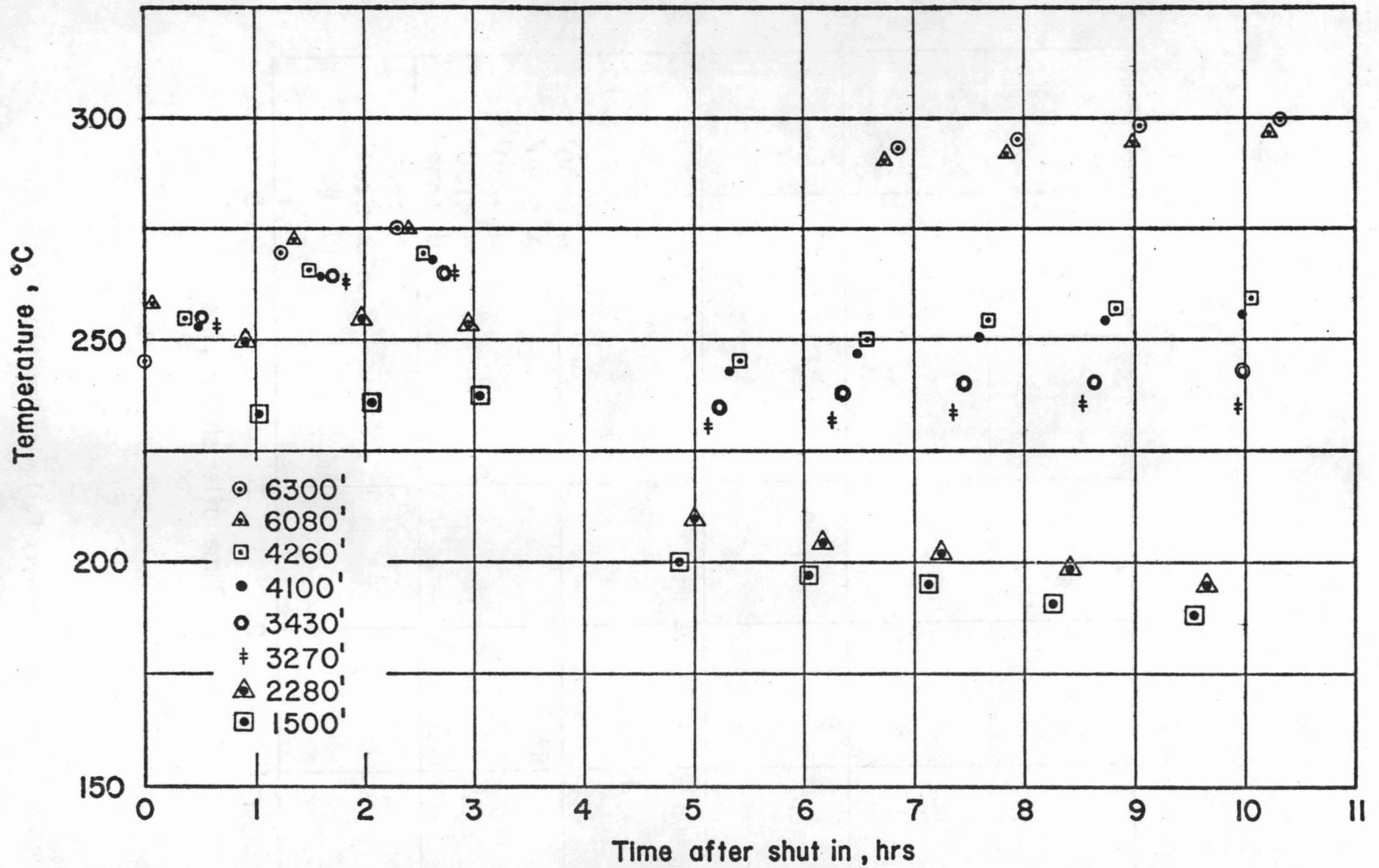

Figure 47. Temperature Recovery following March-May Flow Test

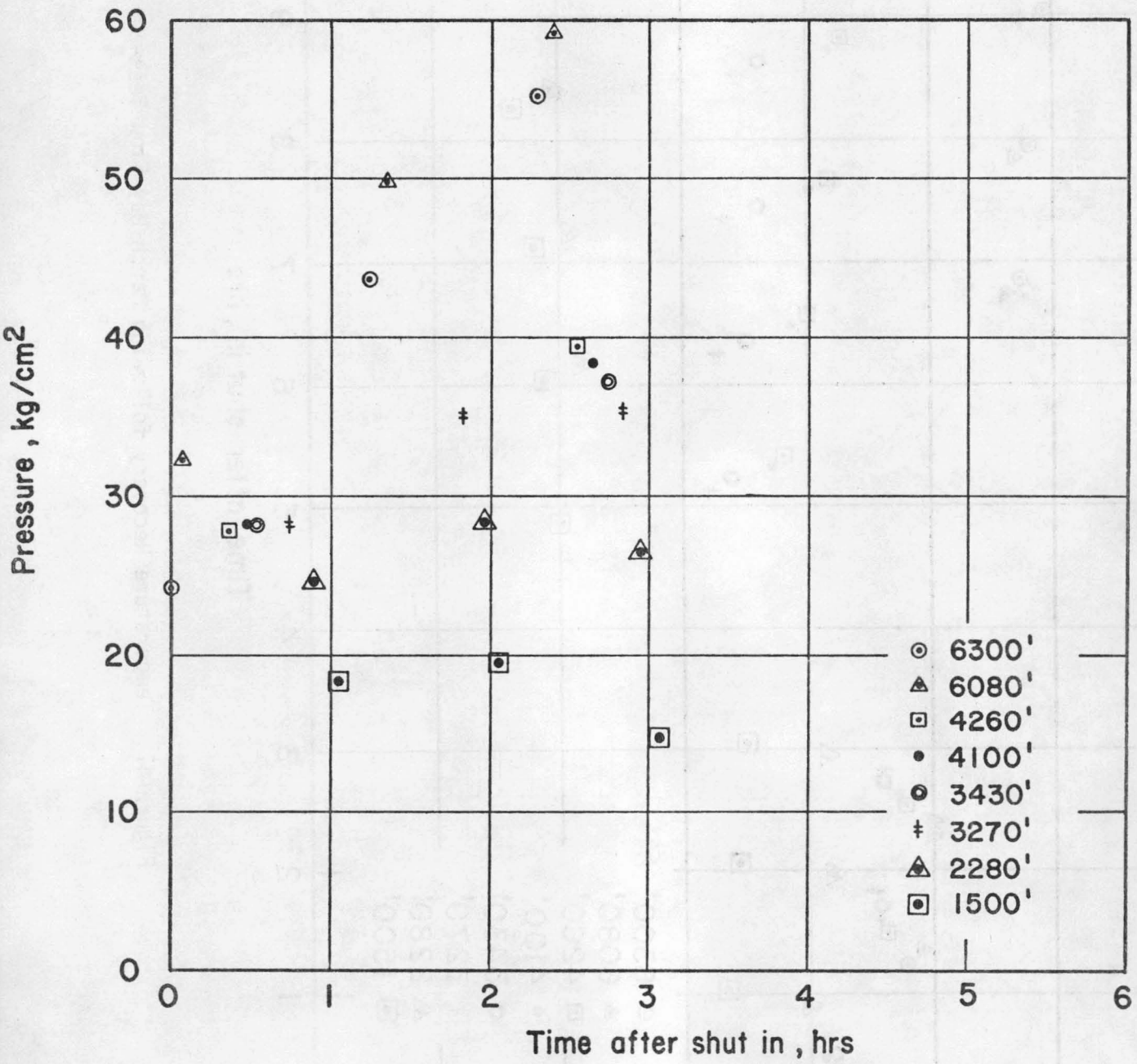
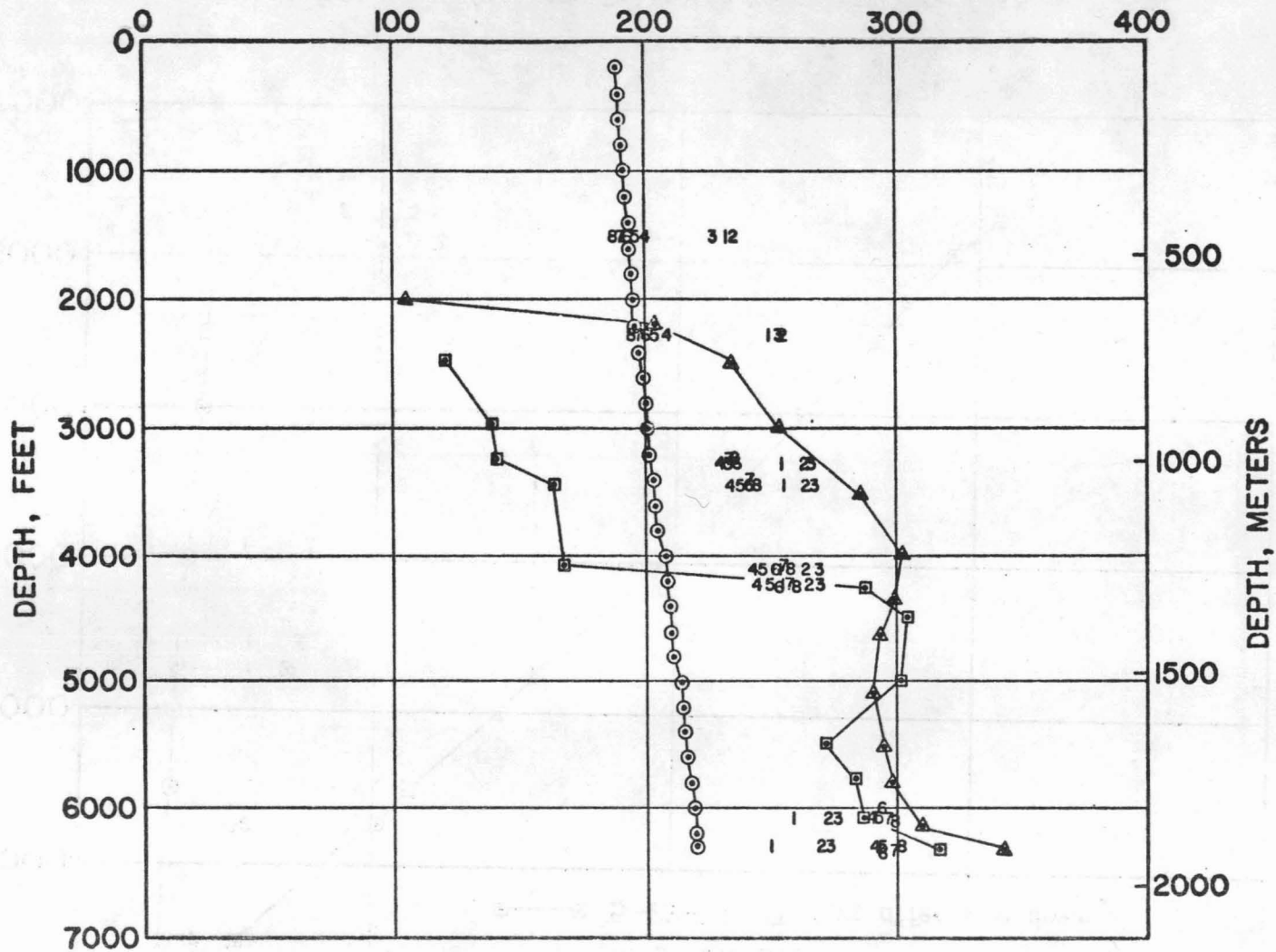

Figure 48. Pressure Recovery Following March-May Flow Test

TEMPERATURE, °C



-75-

Figure 49

MARCH-MAY FLOW TEST (42 DAYS)

- 4-19-77 Well Flowing, 3" Orifice plate in 5 5-9-77 5th profile set after shut down
- 1 5-9-77 1st profile set after shut down 6 5-9-77 6th " " " " "
- 2 5-9-77 2nd " " " " " 7 5-9-77 7th " " " " "
- 3 5-9-77 3rd " " " " " 8 5-9-77 8th " " " " "
- 4 5-9-77 4th " " " " " □—□ 5-22-77 13 days after shut down
- ▲—▲ 8-10-77 93 " " " " "

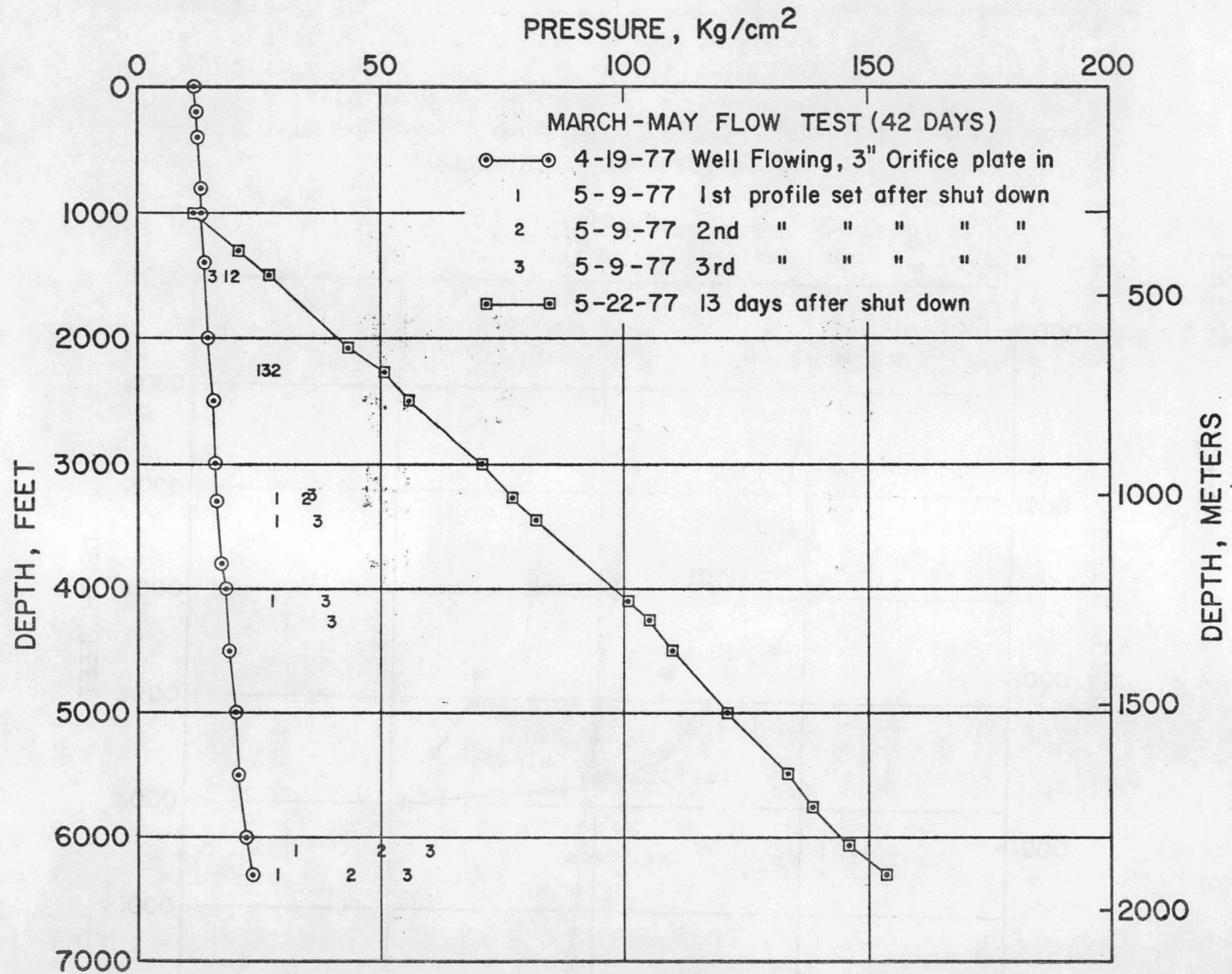

Figure 50. Pressure Recovery Following March-May Flow Test

Noise Level Reduction

An apparent noise problem was encountered during the first long-term flow test (four hours) on July 19, 1976. The sound readings approached levels equivalent to an ascending 747 jumbo jet (~ 122 dB at the roadside). Figure 51 and Table 9 present the recorded noise level during this period.

In anticipation of the longer flow tests, a silencer/separator unit was installed at the site. The noise level was reduced substantially -- 87 dBA was recorded at the roadside. The average sound level about the fenced area (50' x 80') was approximately 101 dBA. Since the permissible exposures expressed in Table 8 are:

TABLE 8

<u>Overall Sound Pressure Level (dB)</u>	<u>Time of Exposure (min)</u>
90	300
100	50
110	16
120	8
125	5

(Reference: Symposium on Noise in Industry, University of Adelaide, 1968, Vol. 2)

all workers and visitors were required to wear ear muffs within the security fencing.

During the November and December flow tests, however, numerous complaints were received from the nearby residents about this roaring noise. Therefore, some modifications were made to remedy the problem. These included circular stiffeners welded at two heights on each vertical stack and a specially-built horizontal discharge line. The muffler, of standard design, is six feet long and made up of two annular sections, the inner one filled with

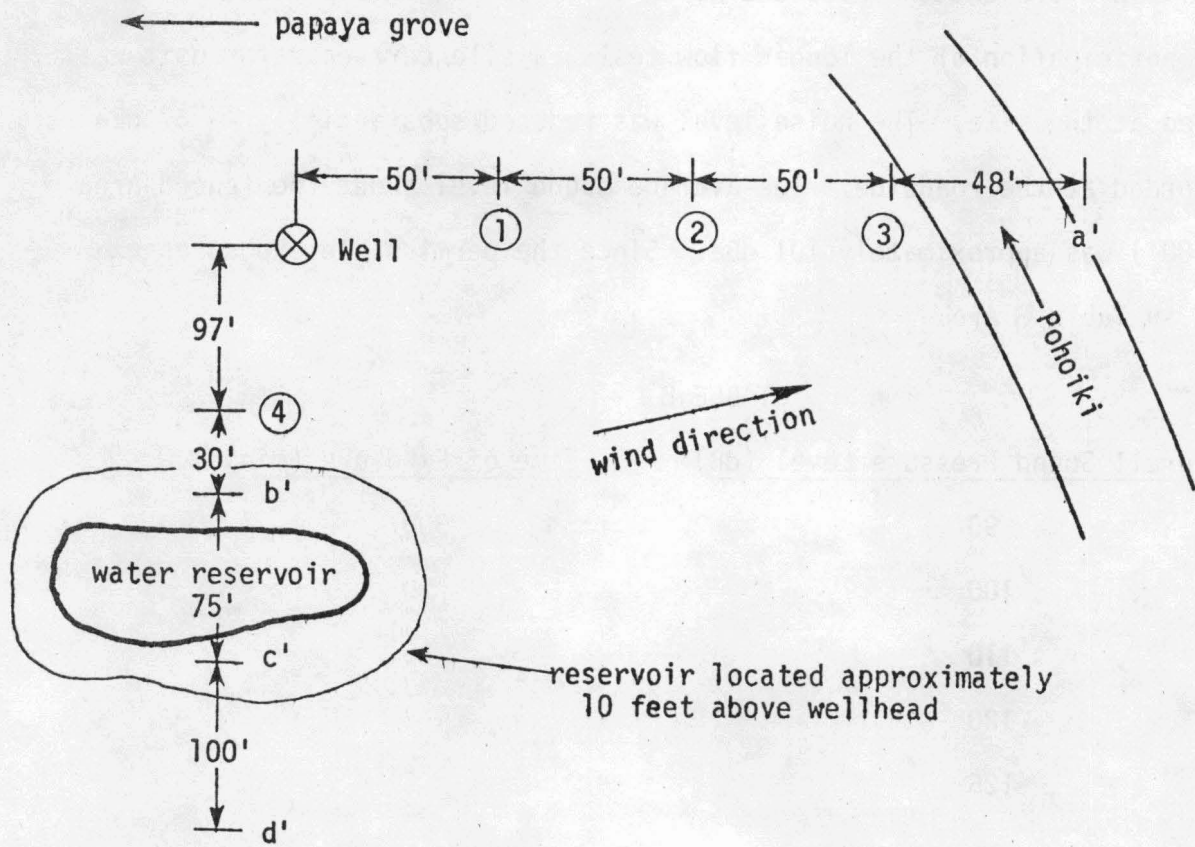

Figure 51. Noise Levels During July 22, 1976 Flow Test

TABLE 9
NOISE MEASUREMENTS

July 19, 1976

Vertical Discharge (discharged at 12:42 pm)

position	sound level (dBC)	time
1	94	12:42
2	100	12:42
3	105	12:43
4	113	12:44
1	125	12:44
2	125	12:45
3	122	12:45
a'	122	12:46
4	124	12:47
1	124	12:49
2	122	12:49
3	120	12:50
4	122	12:51
1	125	12:52
2	117	12:52
3	117	12:43
4	119	12:54
b'	112	12:58 (113, 1:03)
c'	107	12:59
d'	91	1:02
1	119	1:05
2	114	1:06
3	113	1:06
4	116	1:04

Horizontal Discharge (93 dBC, 2" discharge @ ①)

position	dBC	time
1	113	1:25
2	111	1:25
3	112	1:26
4	116	1:27
b'	108	1:28

Vertical Discharge

1	117	1:56
2	112	1:56
3	112	1:57
4	113	1:52

cinders for absorption of the noise, while the outer section is empty (Figure 52).

These changes resulted in decreasing the low frequencies associated with uncomfortable sensations of the chest and abdominal area (15 - 45 Hz). It appeared that while some of the noise sources have been reduced (80 dBa at the roadside), the important source, that of the circular stacks air column was not and that this "organ pipe" remained as the primary source of sound.

Another problem which may have reduced the muffler's efficiency was the silica buildup on the cinder which bonded the particles together into one solid piece.

It was discovered that restricting the fluid flow via orifice plates also reduced the noise level. The full flow sound readings were decreased by an average of six decibels with the addition of the 1 3/4" orifice plate. Figure 53 and Table 10 show the sound measurements recorded for each production flow test.

SCALE DEPOSITION

There is a substantial problem associated with the deposition of scale, primarily from dissolved silica. As an example, the muffler that was installed to reduce noise (refer to Figure 52) uses an annular region filled with cinders as a sound absorbing agent. However, after only 16 days of flow, the scale deposited was sufficient to cement the cinders together so that removal required extensive chipping of the bound cinders.

Figure 52

HAWAII GEOTHERMAL PROJECT
FLOW TEST EQUIPMENT AND INSTRUMENTATION
WITH MUFFLER

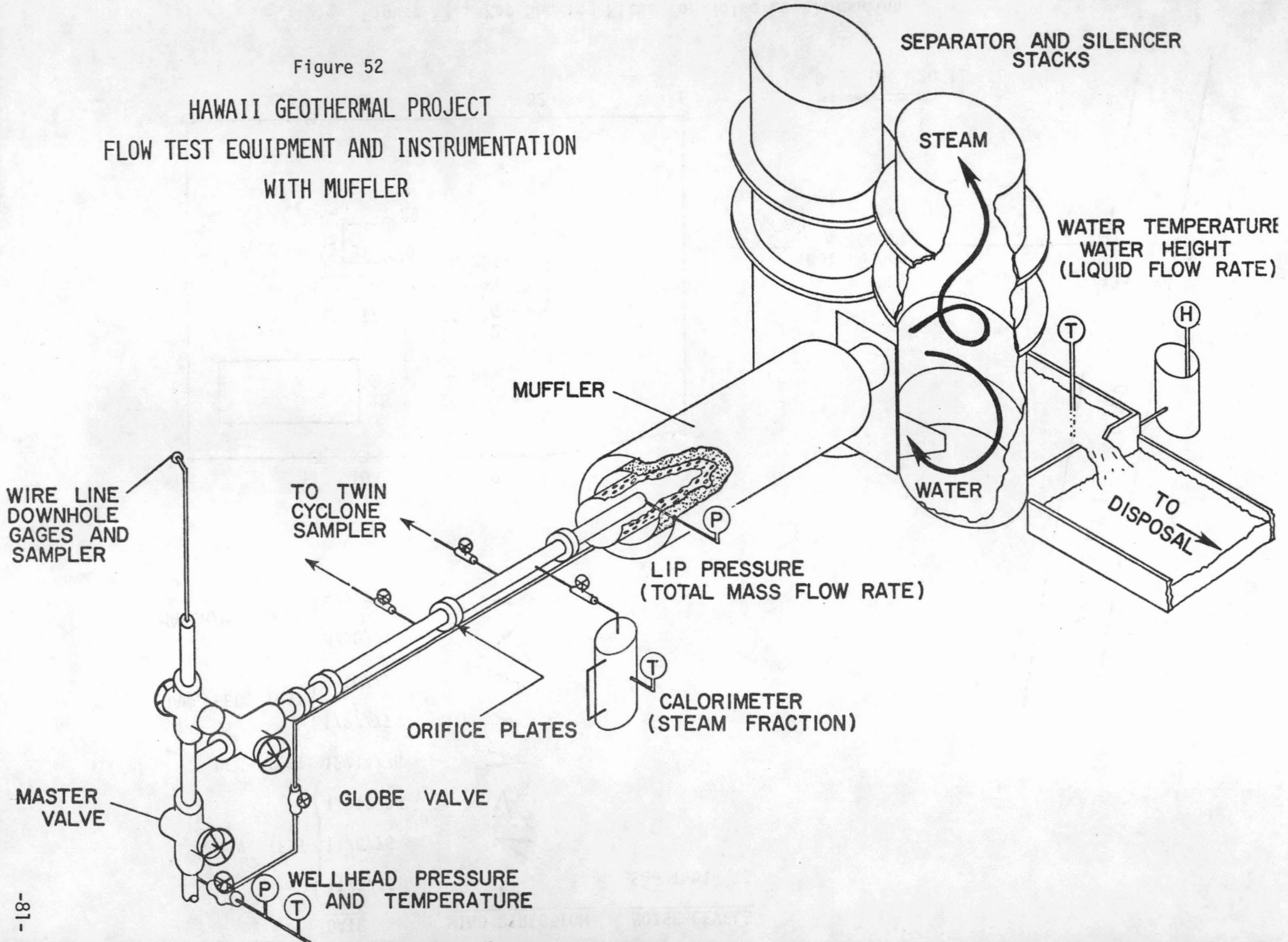

	<u>DATE</u>	<u>WIND DIRECTION</u>	<u>NOISE LEVELS</u>
NOV. TEST	11/3/76	↑	See Table 10
	11/6/76	↗	
	11/17/76	↓	
DEC. TEST	12/14/76	↘	
JAN./FEB. TEST	1/27/77	↙	
	2/10/77	↙	
MARCH/MAY TEST	3/30/77	↙	
	5/7/77	↙	

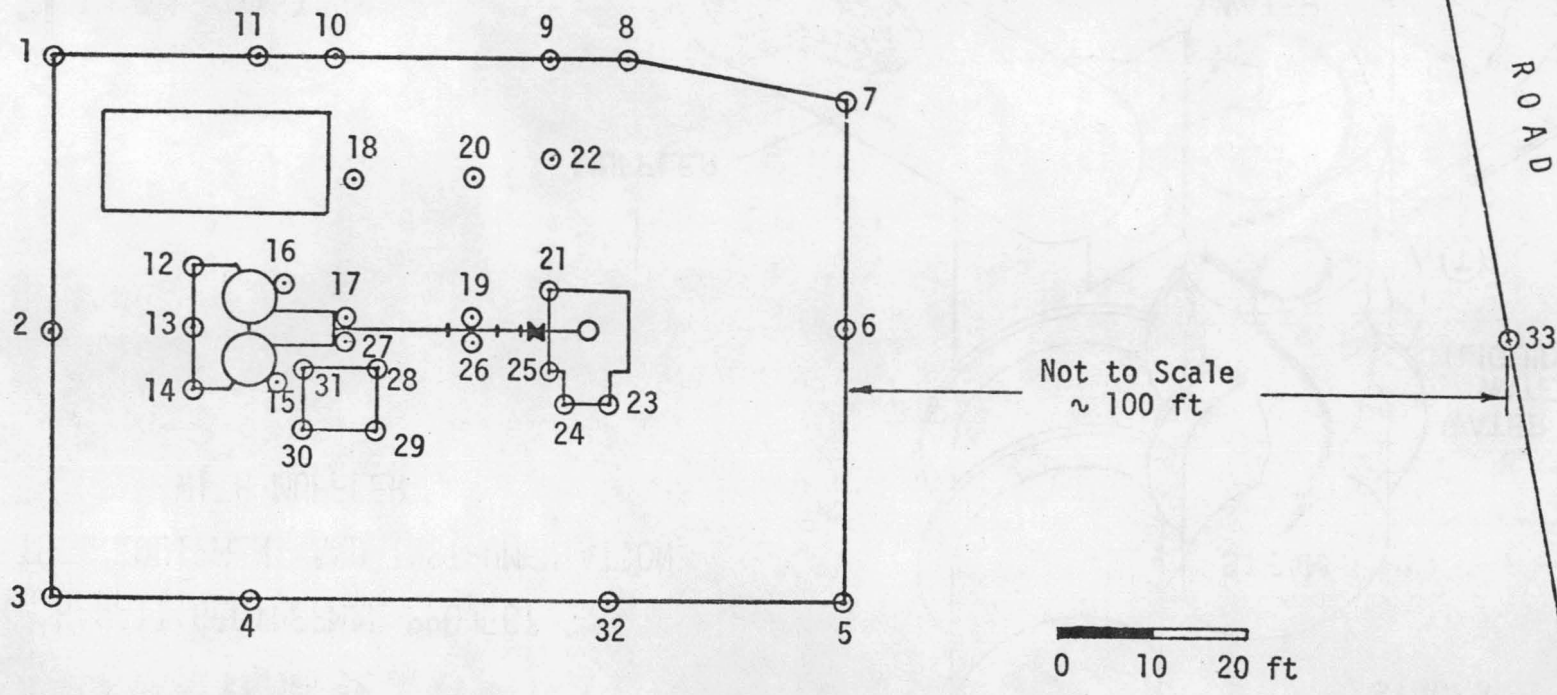

Figure 53. Map Showing Sites for Noise Level Readings

TABLE 10

Noise Level Readings on DBA Scale
(See Figure 53 for locations of stations)

Station	11/3 flashed 11/3 recorded 11/6 recorded	11/3 flashed 11/17 recorded	12/12 flashed 12/14 recorded	1/26 flashed 1/27 recorded	2/10/77 1 3/4" Orifice	3/30/77 3" Orifice	5/7/77 3" Orifice
1	100/98	98	99	96	92	98	-
2	104	102	104	100	92	100	98
3	98/106	95	96	93	85	95	91
4	98	96	100	96	87	96	94
5	98/98	94	94	89	80	91	-
6	96	92	95	90	81	91	89
7	98/97	96	97	91	82	91	89
8	99	97	98	93	85	93	91
9	98	97	99	94	88	95	93
10	98	96	99	96	89	96	94
11	101	98	100	96	90	-	-
12	107	103	106	100	93	101	99
13	110	108	110	103	96	103	101
14	107	102	104	100	93	100	98
15	106	102	106	102	96	103	100
16	104	101	105	101	93	102	99
17	110	105	108	101	96	102	99
18	106	102	106	99	93	100	98
19	103	102	104	99	95	99	97
20	103	99	100	96	90	96	95
21	104/101	99	101	98	92	97	95
22	100	98	99	96	87	96	94
23	100/99	97	98	94	87	94	92
24	99	97	98	95	88	95	93
25	106/101	99	101	95	90	96	95
26	103	99	101	98	93	98	96
27	110	104	109	103	97	102	100
28	110/107	103	107	102	96	102	100
29	96	94	96	91	86	93	90
30	108	104	106	101	96	103	102
31	106	104	108	100	94	102	99
32	97	95	-	-	-	-	-
33	87/-	-	-	80	74	80	75

SUMMARY

HGP-A has undergone five flash discharge tests since an initial flashing on July 2, 1976. The maximum bottomhole temperature during quiescent periods has been measured by 358°C.

Comparison of flow characteristics during the early stages of the last flow tests shows that with each subsequent test the flow rate has increased. A possible explanation for this improvement in well performance is that skin damage due to the use of drilling mud is being alleviated as each flow test partially cleans out embedded mud.

A series of throttled flow tests indicates that there is a substantial increase in wellhead pressure from 51 psig to 375 psig as the mass flow rate is reduced from 101 Klb/hr to 76 Klb/hr. The electrical power output possible from these flow conditions varies from 3.1 to 3.5 MWe.

Temperature and pressure profiles taken during flow tests indicate that the fluid in the wellbore is at saturation conditions with a mixture of liquid and vapor flowing up to the wellhead, that is, with flashing occurring in the reservoir. The pressure profiles consist of three approximately constant gradient lines that intersect at the junction of the casing and slotted liner and at approximately 4300 feet, from which inference can be made that the major production zones are near bottomhole and in the vicinity of 4300 feet.

Pressure drawdown and buildup analyses yield a kh value (product of permeability and production zone thickness) of approximately 1000 millidarcy feet with the pressure drop across the apparent mud-damaged skin to be approximately 500-600 psi. Data points on the log-log Horner type plot seem

to fall on two different but consecutive straight-line approximations. Interpretation of this occurrence is that there are at least two different production layers in the wellbore with different kh values.

Table 11 is a summary of results of tests thus far.

TABLE 11

SUMMARY OF PRELIMINARY TEST RESULTS AND ANALYSES

KAPOHO GEOTHERMAL RESERVOIR

1. LIQUID-DOMINATED
2. TIGHT FORMATION: PERMEABILITY THICKNESS ~1000 MD-FT
3. VERY HIGH TEMPERATURES ~350°C
4. SLIGHTLY BRACKISH WATER
5. POTENTIALLY LARGE RESERVOIR
6. HIGH SILICA CONTENT

HGP-A GEOTHERMAL WELL

1. DURING FLASH BOREHOLE CONTAINS STEAM AND WATER AT SATURATION
2. FLASHING OCCURS IN FORMATION
3. HIGH WELLHEAD PRESSURES ~160 PSI AT 55 KLB/HR STEAM OR
375 PSI AT 39 KLB/HR STEAM
4. PRODUCING REGIONS PROBABLY NEAR BOTTOM HOLE AND 4300 FEET
5. PROBABLY HAS SEVERE SKIN DAMAGE
6. POTENTIAL POWER OUTPUT ~3.5 MWE
7. FLOWS HAVE INCREASED WITH EACH TEST

Chronology of Events at HGP-A

April 28, 1976	Drilling completed to 6456 feet.
April 29	Temperature profile measured.
May 1	Temperature profile measured.
May 2	Temperature profile measured.
May 4	Temperature profile measured.
May 6	Temperature profile measured.
May 11	Temperature profile measured.
May 19	Temperature profile measured.
May 20	Temperature profile measured.
June 4-5	Mud flushed out of well.
June 6	Temperature profile measured.
June 6-7	Pump down test.
June 6	Temperature profile measured.
June 8	Temperature/pressure profile measured.
June 11	Temperature profile measured.
June 15	Temperature profile measured.
June 19-20	Temperature/pressure profile measured.
June 22-24	First air lifting attempt -- unsuccessful because ~250' of air hose was lost down the well.
June 26	Temperature profile measured.
June 30	Temperature/pressure profile measured.
July 1-2	Second air lifting attempt -- successful -- well flashed for ~5 minutes.
July 3-6	Wellbore heated daily.
July 6	Temperature/pressure profile measured.

July 7, 1976 Wellbore heated and temperature profile measured.

July 8-12 Wellbore heated daily.

July 12 Temperature/pressure profile measured with the discharge temperature kept constant at ~80°C.

July 13 Wellbore heated.

July 14 Wellbore heated and temperature/pressure profile measured with the discharge temperature kept constant at ~86°C.

July 15-18 Wellbore heated daily.

July 19 Wellhead instrumentation set up. Well flashed vertically as well as horizontally for about 1 hour.

July 20-21 Wellbore heated daily.

July 22 Well flashed for 4 hours. Temperature/pressure profile measured after well was shut in.

July 29 Temperature/pressure profile measured.

August 4 Temperature/pressure profile measured.

August 12 Temperature/pressure profile measured.

August 17 Downhole water samples obtained.

August 18 Temperature profile measured -- downhole water samples obtained.

August 19 Downhole water samples obtained.

August 26 Temperature profile measured.

Sept. 2 Temperature/pressure profile measured.

Sept. 11 Temperature/pressure profile measured.

Sept. 26 Temperature profile measured.

Oct. 6 Casing integrity test conducted to determine whether casing has collapsed at any point; results negative.

Oct. 12 Downhole water samples obtained. Temperature profile measured on lower half of well.

Oct. 13 Temperature profile measured on upper half of well. Water influx test conducted to determine whether production regions might be at 2090', 4320', and 5747'; clock failure led to inconclusive results.

Oct. 21-28, 1976 Silencer/separator, discharge line installed. Instrument shack erected. Dry well excavated. Kicker installed.

Oct. 29-30 Downhole water samples obtained.

Oct. 31 Temperature/pressure profiles measured. Second water influx test conducted at the same depths, but clocks failed again.

Nov. 1-2 Wellbore heated slowly.

Nov. 3 Start of two week flow test.

Nov. 8 Security fence completed. Lighting and electrical lines installed.

Nov. 13 Ten foot dummy probe sent downhole while well was flowing to determine whether temperature/pressure profiles can be measured during flow. Probe caught in wellhead.

Nov. 17 Well shut in at end of two week flow test.

Nov. 18 Dummy probe removed.

Nov. 19 Temperature/pressure profiles measured. Water depth measured.

Nov. 20 Water depth measured.

Nov. 21 Temperature/pressure profiles measured. Water depth measured.

Nov. 22-28 Water depth measured daily.

Nov. 30 Temperature profile measured.

Dec. 1 Water depth measured.

Dec. 2 Downhole water samples obtained. Water depth measured.

Dec. 3 Water depth measured.

Dec. 4 Temperature profile measured. Water depth measured.

Dec. 5-7 Water depth measured daily.

Dec. 8 Temperature profile measured. Water depth measured.

Dec. 9 Water depth measured.

Dec. 10 Well flow induced by air lifting.

Dec. 11 Wellbore heated.

Dec. 12 Start of one week flow test.

Dec. 14, 1976 Temperature/pressure probes lost while making downhole measurements.

Dec. 15 Flow throttled to a lip pressure of ~4 psig.

Dec. 16-17 Temperature/pressure profiles measured with the lip pressure set at ~4 psig.

Dec. 19-20 Well shut in and pressure buildup test started. The clock failed so the well had to be opened and flow resumed. After well flow stabilized, the well was shut in once more. Pressure probes were continually sent downhole for pressure bottomhole measurements.

Dec. 21-26 Bottomhole pressure and water depths measured daily.

Dec. 27-29 Water depth measured daily.

Dec. 30 Bottomhole pressure and water depth measured.

Jan. 1, 1977 Bottomhole pressure and water depth measured.

Jan. 3 Temperature/pressure profile measured. Water depth measured.

Jan. 4-6 Water depth measured daily.

Jan. 7 Silencer removed for modifications.

Jan. 8 Bottomhole pressure and water depth measured.

Jan. 10-14 Water depth measured daily. Geophysics people running tests at well site.

Jan. 15 Temperature/pressure profiles measured. Water depth measured.

Jan. 17 Water depth measured.

Jan. 19 Water depth measured. Separator stacks removed for modifications. Muffler installed.

Jan. 21 Muffler filled with sound absorbent material: cinder.

Jan. 24 Water depth measured.

Jan. 25 Water flows out of discharge line. Downhole water samples obtained. All modifications at well site completed: muffler, stacks, platform, spool and stilling basin.

Jan. 26 Downhole and surface water samples obtained. Well surged three times to clean the well. Start of 15 day flow test.

Jan. 28 Temperature/pressure profile measured with well flowing.

Jan. 29, 1977 6" orifice plate installed.

Jan. 30 4" orifice plate installed.

Feb. 1 Temperature/pressure profile measured with 4" orifice plate in place.

Feb. 2 3" orifice plate installed.

Feb. 3 2 3/8" orifice plate installed.

Feb. 4 Temperature/pressure profile measured with 2 3/8" orifice plate in place.

Feb. 6 2" orifice plate installed.

Feb. 8 1 1/2" orifice plate installed. A pinhole leak in the discharge line was detected. A welder came out to fix it. 1 3/4" orifice plate installed.

Feb. 9 Temperature/pressure profile measured with 1 3/4" orifice plate in place.

Feb. 11-12 Well shut in and pressure buildup test started. Pressure probes were sent down continually for bottomhole pressure measurements.

Feb. 13 Bottomhole pressure and water depth measured.

Feb. 14-15 Bottomhole pressure and water depth measured. Downhole water samples obtained.

Feb. 16-18 Bottomhole pressure and water depth measured daily. Muffler interior examined -- cinder bonded together by silica.

Feb. 19 Temperature/pressure profile measured. Water depth measured.

Feb. 21, 23-24 Bottomhole pressure and water depth measured.

Feb. 25 Temperature/pressure profile measured. Water depth measured.

Feb. 27 Bottomhole pressure and water depth measured.

Feb. 28 Water depth measured.

March 5 Bottomhole pressure and water depth measured.

March 7 Water depth measured.

March 8 Temperature/pressure profile measured. Water depth measured. The bonded cinder in the muffler was partially removed with an air-hammer.

March 9-15 Bonded cinder in the muffler was partially removed. Water depth measured periodically.

March 16, 1977 Water depth measured.

March 17 Temperature/pressure profile measured. Water level at ground level.

March 18-20 Wellbore heated daily.

March 21-27 Well surged daily for approximately one hour.

March 28 Start of 42-day flow test.

March 29 3" orifice plate installed.

April 5 Temperature/pressure profile measured. Downhole water samples attempted -- no fluid present in container.

April 6 Downhole water samples attempted -- little fluid present.

April 12 Temperature/pressure profile measured.

April 19 Temperature/pressure profile measured.

April 27 Pressure profile measured.

May 9-10 Well shut in and temperature/pressure profile measured constantly for three hours, temperature profile measured constantly for next six hours, bottomhole pressure measured, then downhole water samples were obtained: two at 6300' and one at 4300' before. Water sampler and 1000' of wire lost downhole.

May 11-16 Well site cleaned; wellhead, discharge line, muffler and instrument shed repainted. Old wire line removed from spool.

May 17 Cable from Geophysics fitted on HGP's spool -- too large.

May 18 Fishing attempt with a borrowed winch set up. Wire bundles were retrieved on three separate occasions -- nothing on two others.

May 19 Fishing attempted -- no wire or water sampler was retrieved on three occasions.

May 22 Temperature/pressure profile measured. Water depth measured.

May 28 Water depth measured.

June 1 Water depth measured.

June 4 Water depth measured.

June 8 Water depth measured.

June 11, 1977	Water depth measured.
June 15	Water depth measured.
June 18	Water depth measured.
June 22	Water depth measured.

TECHNICAL PAPERS

- Chen, B., et al., "Well Test Results from HGP-A," Geothermal Resources Council 1978 Annual Meeting, pp. 99-102, Hilo, Hawaii (1978).
- Chou, J., et al., "Regenerative Vapor Cycle with Isobutane as Working Fluid," Geothermics, Vol. 3, No. 3, pp. 93-99, 1974.
- Kihara, D. and P. Fukunaga, "Working Fluid Selection and Preliminary Heat Exchanger Design for a Rankine Cycle Geothermal Power Plant," Proceedings of Second U.N. Symposium on Development and Use of Geothermal Resources, Vol. 3, pp. 2013-2020, 1975.
- Kihara, D., et al., "Instrumentation and Test Results for Hawaii Geothermal Project's HGP-A Well," Summaries of Second Workshop on Geothermal Reservoir Engineering, pp. 109-115, Stanford, California (1976).
- Kihara, D., et al., "The Hawaii Geothermal Project," ANS Topical Meeting on Energy and Mineral Recovery Research, Golden, Colorado (1977).
- Kihara, D., et al., "Summary of Results of HGP-A Well Testing," Summaries of Third Annual Workshop on Geothermal Reservoir Engineering, pp. 138-144, Stanford, California (1977).
- Seki, A., et al., "Geothermal Reservoir Performance Prediction," ASCE Journal of the Power Division, Vol. 104, No. P02, pp. 169-181, 1978.
- Takahashi, P. and B. Chen, "Geothermal Reservoir Engineering," Geothermal Energy, Vol. 3, No. 10, pp. 7-23, 1975.
- Takahashi, P., et al., "State-of-the-Art of Geothermal Reservoir Engineering," ASCE Journal of the Power Division, pp. 111-126, 1975.
- Yuen, P., et al., "Preliminary Well Test Results from HGP-A," Geothermal Resources Council 1977 Annual Meeting, pp. 309-310, San Diego, California (1977).

TECHNICAL REPORTS

- TR No. 1, "Modelling of Hawaiian Geothermal Resources," P. Cheng and P. Takahashi, Nov. 1973.
- TR No. 2, "Steady State Free Convection in an Unconfined Geothermal Reservoir," P. Cheng and K. H. Lau, March 1974.
- TR No. 3, "Geothermal Reservoir Engineering: State-of-the-Art," P. Takahashi, et al., May 1974.
- TR No. 4, "Regenerative Vapor Cycle with Isobutane as Working Fluid," J. Chou, et al., June 1974.
- TR No. 5, "A Parametric Study of a Vertical Heat Exchanger Designed for Geothermal Power Plant Application," G. Shimozono, et al., Sept. 1974.

TECHNICAL REPORTS (continued)

- TR No. 6, "Characteristics of Vapor Flashing Geothermal Plants," R. Ahluwalia and J. Chou, Nov. 1974.
- TR No. 7, "The Effect of Dike Intrusion on Free Convection in Geothermal Reservoirs," K. H. Lau and P. Cheng, Dec. 1974.
- TR No. 8, "Numerical Solutions for Steady Free Convection in Island Geothermal Reservoirs," P. Cheng, et al., Aug. 1975.
- TR No. 9, "The Effect of Steady Withdrawal of Fluid in Geothermal Reservoirs," P. Cheng and K. H. Lau, May 1975.
- TR No. 10, "Free Convection about a Vertical Flat Plate Embedded in a Saturated Medium with Application to Heat Transfer about a Dike," P. Cheng and W. J. Minkowycz, Oct. 1975.
- TR No. 11, "Free Convection about a Vertical Cylinder Embedded in a Porous Medium," W. J. Minkowycz and P. Cheng, Nov. 1975.
- TR No. 12, "Buoyancy Induced Flows in a Saturated Porous Medium Adjacent to Impermeable Horizontal Surfaces," P. Cheng and I. Chang, Nov. 1975.
- TR No. 13, "The Influence of Lateral Mass Efflux on Free Convection Boundary Layers in a Saturated Porous Medium," P. Cheng, April 1976.
- TR No. 14, "Similarity Solutions for Convection of Groundwater Adjacent to Horizontal Impermeable Surfaces with Axisymmetric Temperature Distribution," P. Cheng and W. C. Chau, April 1976.
- TR No. 15, "Combined Free and Forced Boundary Layer Flows about Inclined Surfaces in a Porous Medium," P. Cheng, June 1976.
- TR No. 16, "Similarity Solutions for Mixed Convection from Horizontal Impermeable Surfaces in a Saturated Porous Media," P. Cheng, Aug. 1976.
- TR No. 17, "Numerical Solutions for Transient Heating and Withdrawal of Fluid in a Liquid-Dominated Geothermal Reservoir," P. Cheng and L. Teckchandani, Aug. 1976.
- TR No. 18, "Conceptual Design of a 10MW Regenerative Isobutane Geothermal Power Plant," A. Gupta and J. Chou, Oct. 1976.
- TR No. 19, "The Geothermal Reservoir Engineering of HGP-A: A Summary Report of Activities Up to October 31, 1976," B. Chen, et al., Oct. 1976.
- TR No. 20, "Working Fluid Selection and Preliminary Heat Exchanger Design for a Rankine Cycle Geothermal Power Plant," D. Kihara and P. Fukunaga, May 1975.
- TR No. 21, "Possible Similarity Solutions for Free Convection Boundary Layers Adjacent to Flat Plates in Porous Media," C. Johnson and P. Cheng, Dec. 1976.
- TR No. 22, "Computer Performance Matching and Prediction of Geothermal Reservoirs," A. Seki, et al., March 1977.

TECHNICAL MEMORANDA

TM No. 1, "Warm Water Wells on the Island of Hawaii," S. Shito, Jan. 1974.

TM No. 2, "Geothermal Reservoir and Well Test Analysis: A Literature Survey,"
B. Chen, Sept. 1974.

TM No. 3, "A Review of Problems on Scaling and Corrosion in Geothermal Plants,"
A. Bhargava, et al., June 1975.

QUARTERLY REPORTS

"Quarterly Report No. 1," J. Augustus, et al., Sept. 1, 1973.

"Quarterly Report No. 2," J. Augustus, et al., Dec. 1, 1973.

"Quarterly Report No. 3," J. Augustus, et al., March 1, 1974.

"Quarterly Report No. 4," H. C. Chai, et al., Sept. 16, 1974.

"Quarterly Report No. 5," H. C. Chai, et al., Jan. 15, 1975.

PROGRESS REPORTS

Chai, H. C., et al., "Engineering Program Progress Report," Jan. 1, 1975 to
Aug. 31, 1975.

Chai, H. C., et al., "Phase I Report," Jan. 1975.

"Progress Report on the Drilling Program," May 5, 1976.

"Progress Reports for Federal FY 77", Jan. 1, 1977; April 1, 1977; July 1, 1977.

WELL TESTING REPORTS (monthly)

"Progress Report," Sept. 1, 1976 - Oct. 31, 1976.

"Progress Report," Nov. 30, 1976.

"Progress Report," Jan. 1977.

"Progress Report," Feb. 1977.

"Progress Report," April 1977.